



**PDHonline Course S194 (6 PDH)**

---

# **Determination of Design Loads Specific for Structures in Coastal Areas**

*Instructor: Jeffrey Havelin, PE*

**2020**

**PDH Online | PDH Center**

5272 Meadow Estates Drive  
Fairfax, VA 22030-6658  
Phone: 703-988-0088  
[www.PDHonline.com](http://www.PDHonline.com)

An Approved Continuing Education Provider

# Chapter 11: Determining Site-Specific Loads

## Table of Contents

	Page
11.1	Introduction ..... 11-1
11.2	Dead Loads ..... 11-3
11.3	Live Loads ..... 11-3
11.4	Concept of Tributary or Effective Area and Application of Loads to a Building ..... 11-4
11.5	Snow Loads ..... 11-4
11.6	Flood Loads ..... 11-6
11.6.1	Design Flood ..... 11-6
11.6.2	Design Flood Elevation (DFE) ..... 11-6
11.6.3	Design Flood Depth ( $d_s$ ) ..... 11-7
11.6.4	Wave Setup ( $d_{ws}$ ) Contribution to Flood Depth ..... 11-9
11.6.5	Design Wave Height ( $H_p$ ) ..... 11-9
11.6.6	Design Flood Velocity ( $V$ ) ..... 11-9
11.6.7	Hydrostatic Loads ..... 11-11
11.6.8	Wave Loads ..... 11-14
11.6.9	Hydrodynamic Loads ..... 11-18
11.6.10	Debris Impact Loads ..... 11-22
11.6.11	Localized Scour ..... 11-26
11.6.12	Flood Load Combinations ..... 11-29
11.7	Tsunami Loads ..... 11-36
11.8	Wind Loads ..... 11-36
11.8.1	Main Wind Force Resisting System ..... 11-39
11.8.2	Components and Cladding ..... 11-42
11.9	Tornado Loads ..... 11-48

11.10 Seismic Loads ..... 11-48

11.11 Load Combinations ..... 11-57

11.12 References ..... 11-61

**Figures**

Figure 11-1 Load determination flowchart. .... 11-2

Figure 11-2 Examples of tributary areas for different structural members. .... 11-5

Figure 11-3 Parameters that determine or are affected by flood depth. .... 11-7

Figure 11-4 Velocity vs. design stillwater flood depth in areas not subject to tsunamis. .... 11-11

Figure 11-5 Lateral flood force on a vertical component. .... 11-12

Figure 11-6 Vertical (buoyant) flood force. .... 11-13

Figure 11-7 Dynamic, static, and total pressure distributions against a vertical wall. .... 11-16

Figure 11-8 Water depth vs. wave height, and water depth vs. breaking wave force against a vertical wall (for Case 2, with stillwater behind the wall) for the 1-percent and 50-percent exceedance interval events. .... 11-17

Figure 11-9 Hydrodynamic loads on a building. .... 11-18

Figure 11-10 Determining drag coefficient from width-to-depth ratio. .... 11-20

Figure 11-11 Pile deflection vs. duration of impact (t) for alternative wood pile foundations. .... 11-25

Figure 11-12 Scour at vertical foundation member stopped by underlying scour-resistant stratum. .... 11-26

Figure 11-13 Plan view of site and building, with flood hazard zones. .... 11-31

Figure 11-14 Section A: Primary frontal dune will be lost during 100-year flood because dune reservoir is less than 1,100 ft<sup>2</sup>. .... 11-31

Figure 11-15 Building elevation and plan view of pile foundation. .... 11-32

Figure 11-16	Tsunami velocity vs. design stillwater depth.....	11-36
Figure 11-17	Effect of wind on an enclosed building and a building with an opening. ....	11-38
Figure 11-18	Wind speed map. ....	11-40
Figure 11-19	Wind pressures on the MWFRS on a cross section of the case study building. ....	11-42
Figure 11-20	Wind pressures on the MWFRS. ....	11-43
Figure 11-21	Typical building connections. ....	11-44
Figure 11-22	Building elevation and plan view of roof. ....	11-45
Figure 11-23	Wind pressure zones for the MWFRS. ....	11-46
Figure 11-24	Wind pressure zones for components and cladding; most severe negative pressure coefficients shown. ....	11-47
Figure 11-25	Shear and overturning forces. ....	11-50
Figure 11-26	Gravity further deforms the out-of-plumb frame of the building. ....	11-50
Figure 11-27	Effect of seismic forces on supporting piles. ....	11-50
Figure 11-28	Building elevation and plan view of roof showing longitudinal shearwalls. ....	11-55
Figure 11-29	Side view of building in Figure 11-23. ....	11-59

**Tables**

Table 11.1	Value of Dynamic Pressure Coefficient, $C_p$ , as a Function of Probability of Exceedance .....	11-16
Table 11.2	Drag Coefficients for Ratios of Width to Depth ( $w/d_s$ ) and Width to Height ( $w/h$ ) .....	11-20
Table 11.3	Impact Durations, $t$ , for Use in Formula 11.9 .....	11-25
Table 11.4	Scour Factor for Flow Angle of Attack, $K$ .....	11-28
Table 11.5	Local Scour Depth vs. Soil Type .....	11-28
Table 11.6	Selection of Flood Load Combinations for Design .....	11-29
Table 11.7	Summary of Wind Pressures ( $p$ ) on the MWFRS .....	11-46
Table 11.8	Summary of Wind Pressures for Components and Cladding .....	11-47

**Formulas**

Formula 11.1	Design Stillwater Flood Depth .....	11-8
Formula 11.2	Design Flood Velocity .....	11-10
Formula 11.3	Lateral Hydrostatic Load .....	11-12
Formula 11.4	Vertical (Buoyant) Hydrostatic Force .....	11-13
Formula 11.5	Breaking Wave Load on Vertical Piles .....	11-15
Formula 11.6	Breaking Wave Loads on Vertical Walls .....	11-16
Formula 11.7	Hydrodynamic Load From Flood Flows Moving at Less Than 10 ft/sec .....	11-19
Formula 11.8	Hydrodynamic Load From Flood Flows Moving at Greater Than 10 ft/sec .....	11-21
Formula 11.9	Debris Impact Load .....	11-23
Formula 11.10a	Localized Scour Around Vertical Pile (Non-Tsunami Condition) .....	11-27
Formula 11.10b	Localized Scour Around Vertical Enclosure (Non-Tsunami Condition) .....	11-27
Formula 11.11	Seismic Base Shear by the Simplified Analysis Procedure .....	11-52
Formula 11.12	Vertical Distribution of Seismic Forces .....	11-54

# Determining Site-Specific Loads

## 11.1 Introduction

Chapters 4 and 5 of this manual describe how a design professional would begin to assess the risk of a particular hazard event occurring at a given location. Regulatory requirements that affect coastal construction are discussed in Chapter 6. Chapter 7 presents information about how to identify site-specific hazards and discusses methodologies for delineating hazard zones. Chapter 8 provides guidance on how the siting of a building on a particular lot or parcel influences the magnitude of the hazard effects on the building.

This chapter provides the design professional and others with guidance on how to determine—by calculation or graphical interpretation—the magnitude of the loads placed on a building by a particular natural hazard event or a combination of events. The calculation methods presented in this chapter are intended to serve as the basis of a methodology for applying the calculated loads to the building during the design process. This methodology will be presented in Chapter 12, *Designing the Building*.

The flowchart in Figure 11-1 shows that the process for determining site-specific loads from natural hazards begins with **identifying the building codes** or **engineering standards** in place for the selected site. Be aware, however, that model building codes and other building standards may not provide load determination and design guidance for each of the hazards identified. In such instances, supplemental guidance should be sought.

The procedure continues with the **calculation of the loads** imposed by each of the identified hazards. The final step is to determine the **load combinations** appropriate for the building site. It is possible that some loads will be highly correlated and can be assumed to occur simultaneously (such as during a hurricane, when high winds and flooding are closely related). Other loads, however, are weakly correlated, and their simultaneous occurrence is unlikely (e.g., seismic and flood loads).

The load combinations used in this manual are those recommended in ASCE 7-98 (ASCE 1998b). All of the calculations, analyses, and load combinations presented in this manual are based on **Allowable Stress Design** (ASD). The use of factored loads and Strength Design methods will require the designer to modify the approaches presented in this manual to accommodate ultimate strength concepts.



### NOTE

All coastal residential buildings should be designed and constructed to prevent flotation, collapse, or lateral movement due to the effects of wind and water loads acting simultaneously.



### NOTE

Throughout this manual, the recommendations of the engineering standards ASCE 7-98, *Minimum Design Loads for Buildings and Other Structures* (ASCE 1998b) will be followed unless otherwise noted. ASCE 7-98 includes procedures for calculating dead and live loads; loads due to soil pressure, fluids, wind, snow, atmospheric ice, and earthquake; and load combinations.

Figure 11-1 Load determination flowchart.

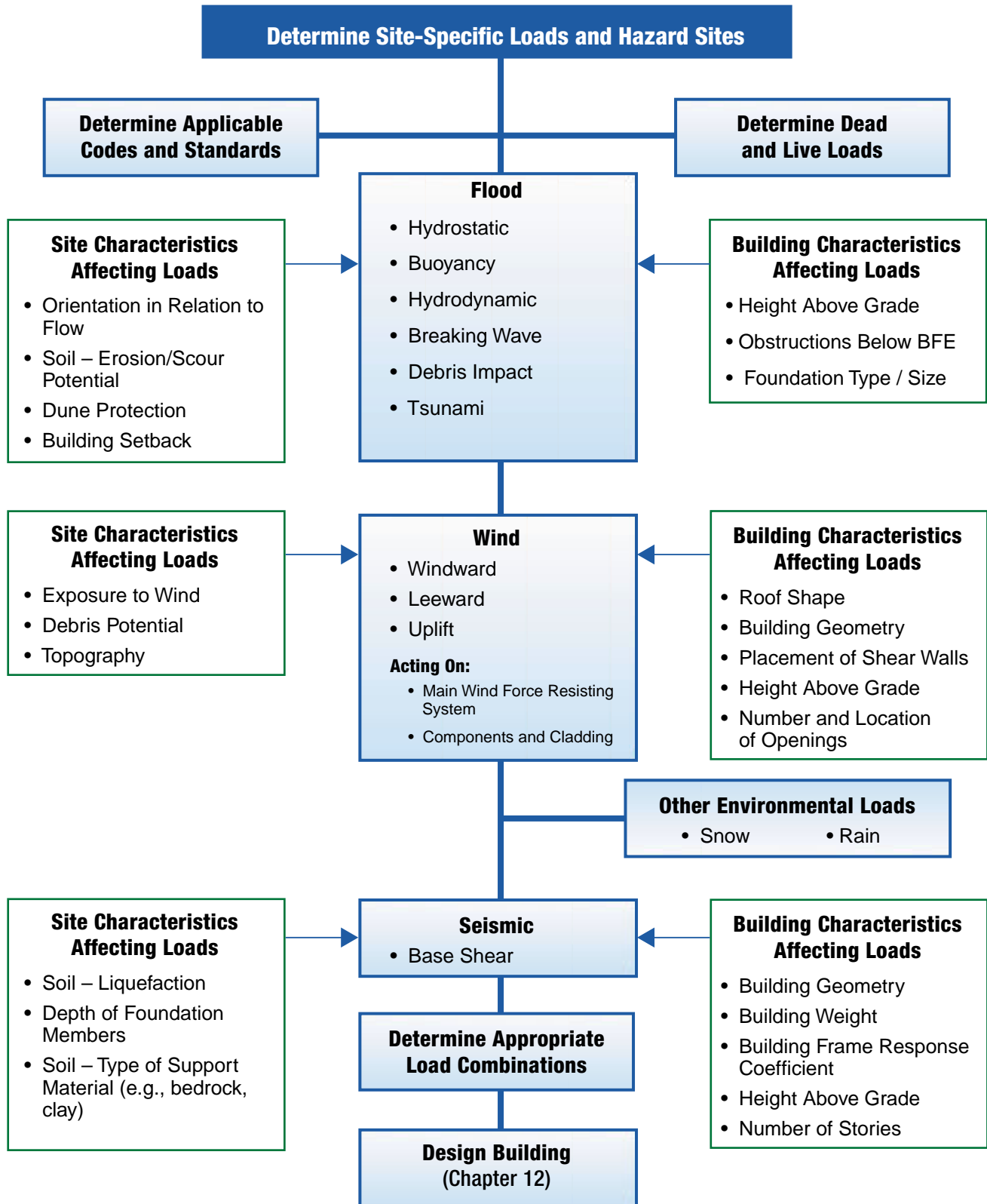

## 11.2 Dead Loads

The first step in determining the loads placed on a building is to determine the weight of the building and its appurtenances (i.e., dead load). The definition of dead load in ASCE 7-98 is “...the weight of all materials of construction incorporated into the building, including but not limited to walls, floors, roofs, ceilings, stairways, built-in partitions, finishes, cladding, and other similarly incorporated architectural and structural items, and fixed service equipment.” The sum of the dead loads of all the individual components will equal the unoccupied weight of the building.

The total weight of a building is usually determined by multiplying the unit weight of the various building materials—expressed in pounds (lb) per unit area—by the surface area of those materials. This approach requires that the designer develop a complete list of all of the materials and determine their representative unit weights. Minimum design dead loads are included in ASCE 7-98, *Commentary*. Additional information about material weights can be found in *Architectural Graphic Standards* (Ramsey and Sleeper 1996) and numerous other texts. A simpler, alternative technique is to determine the surface area of building elements such as exterior walls, floors, and roofs and then develop an average unit weight for each. The total weight is equal to the unit weight of the element multiplied by the area of the element.

Determining dead loads is important for several reasons:

- Foundation size (e.g., footing width, pile embedment depth, number of piles) depends partly on dead load.
- Dead load counterbalances uplift forces due to buoyancy and wind.
- Dead load counterbalances wind and earthquake overturning moments.
- Dead load changes the response of the building to both seismic forces and impact forces generated by floating objects.

## 11.3 Live Loads

ASCE 7-98 defines live loads as “... those loads produced by the use and occupancy of the building ... and do not include construction or environmental loads such as wind load, snow load, rain load, earthquake load, flood load, or dead load.” The flood, wind, and earthquake loads referred to here are the natural hazard loads discussed in detail later in this chapter. For residential one- and two-family buildings, the uniformly distributed live load for habitable areas (except sleeping and attic areas) recommended by ASCE 7-98 is 40 lb/ft<sup>2</sup>. For balconies and decks on one- and two-family buildings not exceeding 100 ft<sup>2</sup>, the recommended uniformly distributed live load is 60 lb/ft<sup>2</sup>. ASCE 7-98 contains no requirements for supporting a concentrated load in a residential building.



## 11.4 Concept of Tributary or Effective Area and Application of Loads to a Building

All loads (e.g., dead, live, snow, flood, wind, seismic) affect a building by acting on some area of the building and being transferred to the structural member(s) that supports that area. Loads are usually applied to a “tributary” area, or the smallest area of the building supported by a structural member. Seismic loads, however, are usually distributed through larger building areas such as an entire roof or floor area. For example, when taken as part of the structural frame, a roof truss spaced 24 inches on center (o.c.) and spanning 30 feet has a tributary area of 2 feet x 30 feet or 60 ft<sup>2</sup>. In this example, one half of the applied load is carried on each supporting wall. Figure 11-2 illustrates tributary areas for roof loads, lateral wall loads, and column or pile loads. The concept of loads being carried by a tributary area is important to the concept of “continuous load path,” which will be fully developed in Chapter 12.

ASCE 7-98 uses effective wind area to define the area of a building component or cladding element that will be affected by wind. Component and cladding elements include items such fasteners, panels, studs, trusses, and window and door mullions. The effective wind area may be the same as the tributary area defined above or, for areas supported by long, slender members (e.g., studs, trusses), may be taken to be at least one third the length of the area (span of the member). Thus, effective area is used only in the determination of the gust coefficient  $GC_p$ .

## 11.5 Snow Loads

Snow loads are applied as a vertical load on the roof or other flat, exposed surfaces such as porches or decks. Recommended ground snow loads are normally specified by the local building code or building official; however, ASCE 7-98 (ASCE 1998b) includes a map of the United States with recommended snow loads that can be used in the absence of local snow load information. The weight of snow is added to the building weight when the seismic force is determined. Chapter 16 of the *International Building Code* 2000, hereafter referred to as the IBC 2000 (ICC 2000a) contains information about how to apply snow loads for this purpose.



### CROSS-REFERENCE

See ASCE 7-98 and Section 11.8.2 of this manual for additional information regarding effective wind area.

Figure 11-2 Examples of tributary areas for different structural members.

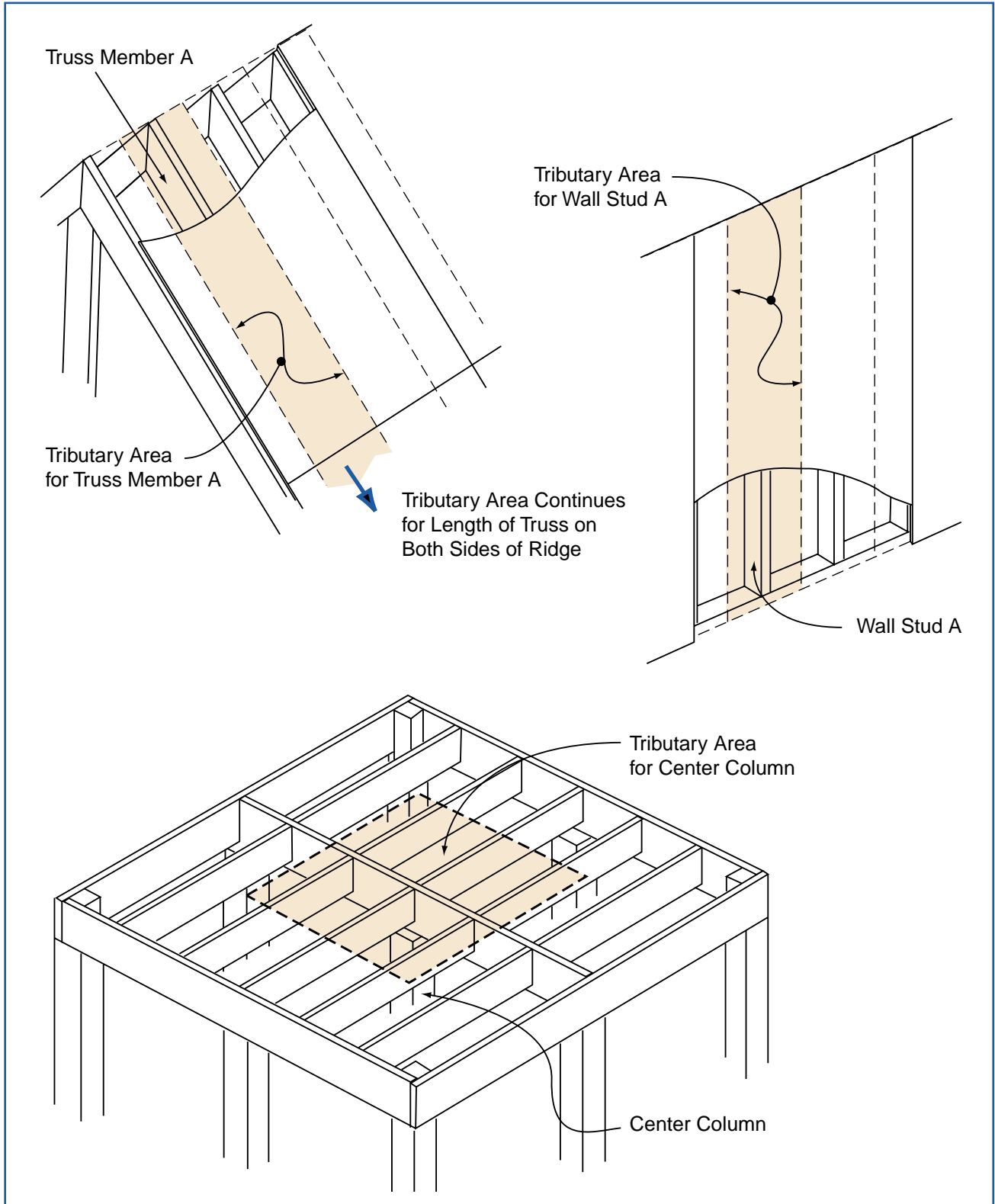



## NOTE

1. Flood load calculation procedures cited in this manual are **very conservative**, given the uncertain conditions that will exist during a severe coastal event.
2. Background information and calculation procedures for determining coastal flood loads are presented in a number of publications, including ASCE 7-98 (ASCE 1998b), ASCE 24-98 (ASCE 1998a), and the U. S. Army Corps of Engineers (USACE) *Coastal Engineering Manual* (scheduled for release in 2000 and available at the USACE website at <http://bigfoot.wes.army.mil/cem001.html>).



## DEFINITION

**Freeboard** is an additional amount of height incorporated into the DFE to account for uncertainties in the determination of flood elevations and to provide a greater level of flood protection. Freeboard may be required by state or local regulations or simply desired by a property owner.

## 11.6 Flood Loads

Flood waters can create a variety of loads on building components. Both hydrostatic and breaking wave loads depend explicitly on flood depth. Coastal engineers also assume, as a first approximation, that hydrodynamic loads will be a function of flood depth. This assumption results from the fact that many coastal flood currents are generated by waves—the assumption will not hold in riverine floods. Flood loads include the following:

- hydrostatic, including buoyancy or flotation effects (from standing water, slowly moving water, and non-breaking waves)
- breaking wave
- hydrodynamic (from rapidly moving water, including broken waves and tsunami runup)
- debris impact (from waterborne objects)

**The effects of flood loads on buildings can be exacerbated by storm-induced erosion and localized scour, and by long-term erosion, all of which can lower the ground surface around foundation members and cause the loss of load-bearing capacity and the loss of resistance to lateral and uplift loads.**

### 11.6.1 Design Flood

For the purposes of this manual, the term design flood refers to the locally adopted regulatory flood. If a community regulates to minimum NFIP requirements, the design flood is identical to the *base flood* (the flood that has a 1-percent probability of being equaled or exceeded in any given year). If a community chooses to exceed minimum NFIP requirements, the design flood can exceed the base flood. **The design flood will always be greater than or equal to the base flood.**

### 11.6.2 Design Flood Elevation (DFE)

Many communities have chosen to exceed minimum NFIP building elevation requirements, usually by requiring **freeboard** above the BFE (see Figure 11-3), but sometimes by regulating to a more severe flood than the base flood. This manual uses the term design flood elevation (DFE) to refer to the locally adopted regulatory flood elevation. If a community regulates to minimum NFIP requirements, the design flood elevation is identical to the **base flood elevation** (BFE). If a community chooses to exceed minimum NFIP elevation requirements, the design flood elevation will exceed the base flood elevation. **The DFE will always be greater than or equal to the BFE.**

### 11.6.3 Design Flood Depth ( $d_s$ )

In the general sense, flood depth can refer to two depths (see Figure 11-3):

1. The vertical distance between the eroded ground elevation and the stillwater elevation associated with the design flood—this depth will be referred to as the design stillwater flood depth,  $d_s$ .
2. The vertical distance between the eroded ground elevation and the DFE—this depth will be referred to as the design flood protection depth,  $d_{fp}$ , but will not be used extensively by this manual. This manual will emphasize use of the DFE as the minimum elevation to which flood-resistant design and construction efforts should be directed.

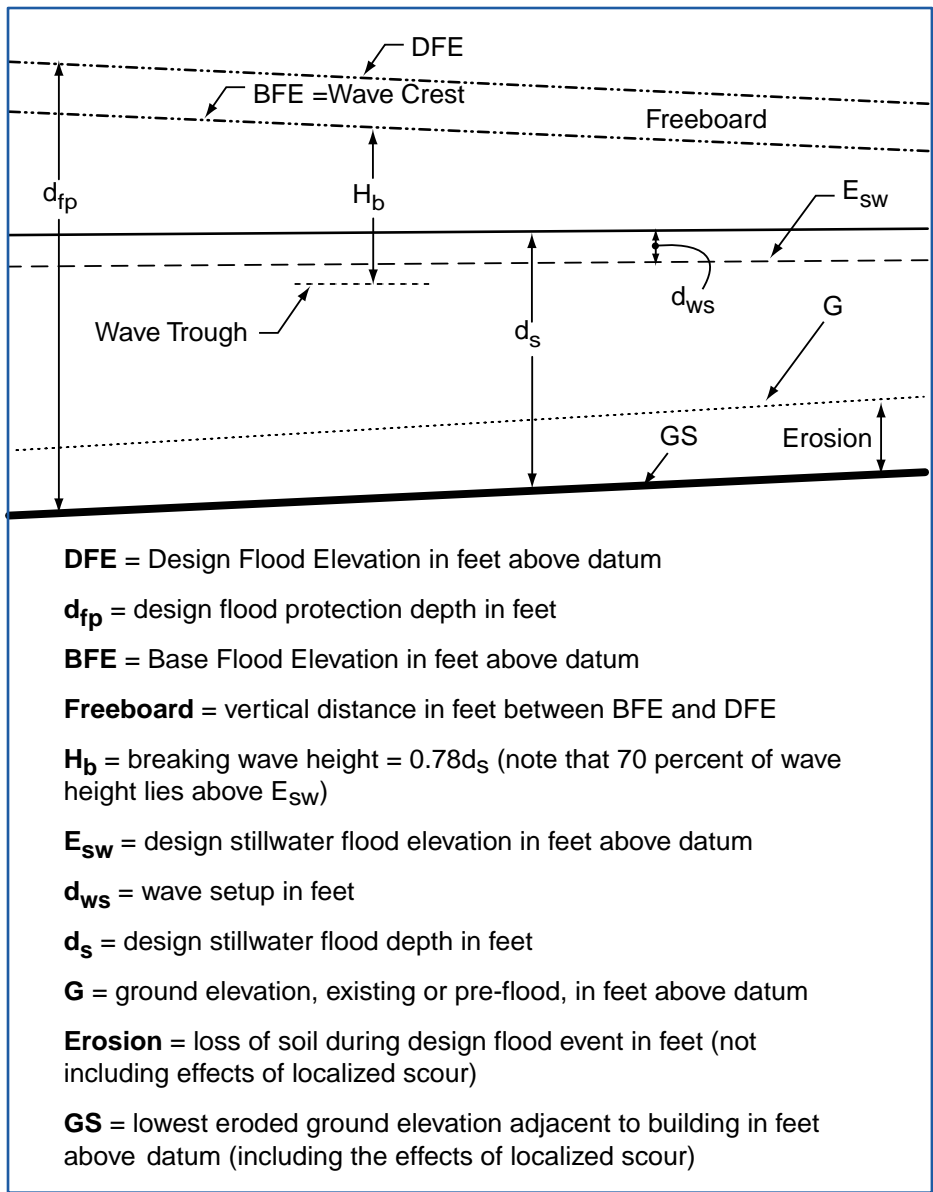

#### NOTE

The design stillwater flood depth ( $d_s$ ) (including wave setup—see Section 11.6.4) should be used for calculating wave heights and flood loads. The design flood protection depth ( $d_{fp}$ ) should be used for building elevation purposes, but **not** for calculating wave heights or flood loads.

**Figure 11-3**  
Parameters that determine or are affected by flood depth.



#### DEFINITION

**Wave setup** is an increase in the stillwater surface near the shoreline, due to the presence of breaking waves. Wave setup typically adds 1.5 –2.5 feet to the 100-year stillwater flood elevation.



#### CROSS-REFERENCE

See Section 11.6.11 for a discussion of localized scour.

**Determining the maximum design stillwater depth over the life of a building is the single most important flood load calculation that will be made**—nearly every other coastal flood load parameter or calculation (e.g., hydrostatic load, design flood velocity, hydrodynamic load, design wave height, DFE, debris impact load, local scour depth) depends directly or indirectly on the design stillwater flood depth.

For the purposes of this manual, the design stillwater flood depth ( $d_s$ ) is defined as the difference between the total stillwater flood elevation ( $E_{sw}$  + wave setup, if not already included in the 100-year stillwater elevation) and the lowest eroded ground surface elevation (**GS**) adjacent to the building (see Formula 11.1).



### NOTE

Flood loads are applied to structures as follows:

**Hydrostatic Loads:** at 2/3 depth point

**Breaking Wave Loads:** at stillwater level

**Hydrodynamic Loads:** at mid-depth point

**Debris Impact Loads:** at stillwater level

#### Formula 11.1 Design Stillwater Flood Depth

$$d_s = E_{sw} + d_{ws} - GS$$

where:

$d_s$  = design stillwater flood depth (feet)

$E_{sw}$  = design stillwater flood elevation in feet above datum (e.g., NGVD, NAVD)

$d_{ws}$  = wave setup in feet

**GS** = lowest eroded ground elevation, in feet above datum, adjacent to building, excluding effects of localized scour around pilings

Figure 11-3 illustrates the relationships among the various flood parameters that determine or are affected by flood depth. Note that in Figure 11-3 and in Formula 11.1, **GS** is not the lowest existing pre-flood ground surface; it is the lowest ground surface that will result from long-term erosion and the amount of erosion expected to occur during a design flood, excluding local scour effects. The process for determining **GS** is described in detail in Chapter 7.

Values for  $E_{sw}$  are not shown on a FEMA Flood Insurance Rate Map (FIRM), but they are given in the Flood Insurance Study (FIS) report, which is produced in conjunction with the FIRM for a community. FIS reports are usually available from community officials and from NFIP State Coordinating Agencies (see Appendix D). Some states have placed FIS reports on their World Wide Web sites.

### 11.6.4 Wave Setup ( $d_{ws}$ ) Contribution to Flood Depth

Older FIS reports and FIRMs do not usually include the effects of wave setup, but some newer (post-1989) FISs and FIRMs do. Since the calculation of design wave heights and flood loads depends on an accurate determination of the total stillwater depth, designers should review the effective FIS carefully, using the following procedure:

1. Check the *Hydrologic Analyses* section of the FIS for mention of wave setup. Note the magnitude of the wave setup.
2. Check the *Stillwater Elevation* table of the FIS for footnotes regarding wave setup. If wave setup is included in the listed BFEs but **not** in the 100-year stillwater elevation, add wave setup before calculating the design stillwater flood depth, the design wave height, the design flood velocity, flood loads, and localized scour. If wave setup is already included in the 100-year stillwater elevation, use the 100-year stillwater elevation to determine the design stillwater flood depth, etc. Do not add wave setup to the 100-year stillwater elevation when calculating Primary Frontal Dune erosion.



#### NOTE

Wave setup effects decrease as one moves inland from the shoreline. Consult *Guidelines and Specifications for Wave Elevation Determination and V Zone Mapping* (FEMA 1995b) and a qualified coastal professional if you have questions about how to account for wave setup in flood depth, wave height, and flood load calculations.

### 11.6.5 Design Wave Height ( $H_b$ )

The design wave height at a coastal building site will be one of the most important design parameters. Therefore, unless detailed analysis shows that natural or manmade obstructions will protect the site during a design event, wave heights at a site will be calculated as the heights of **depth-limited breaking waves**, which are equivalent to 0.78 times the design stillwater flood depth (see Figure 11-3). Note that 70 percent of the breaking wave height lies above the stillwater flood level.

### 11.6.6 Design Flood Velocity ( $V$ )

**The estimation of design flood velocities in coastal flood hazard areas is subject to considerable uncertainty.** There is little reliable historical information concerning the velocity of floodwaters during coastal flood events. The direction and velocity of flood waters can vary significantly throughout a coastal flood event. Flood waters can approach a site from one direction during the beginning of the flood event, then shift to another direction (or several directions) during the remainder of the flood event. Flood waters can inundate some low-lying coastal sites from both the front (e.g., ocean) and the back (e.g., bay, sound, river). In a similar manner, flow velocities can vary from close to zero to high velocities during a single flood event. For these reasons, flood velocities should be estimated conservatively—by assuming flood waters can approach from the most critical direction and by assuming flow velocities can be high (see Formula 11.2).



Formula 11.2 Design Flood Velocity	
<b>Lower Bound:</b>	$V = d_s / t$
<b>Upper Bound:</b>	$V = (gd_s)^{0.5}$
<b>Extreme (tsunami):</b>	$V = 2(gd_s)^{0.5}$
where:	<p><b>V</b> = design flood velocity in ft/sec</p> <p><b>d<sub>s</sub></b> = design stillwater flood depth in feet</p> <p><b>t</b> = 1 sec</p> <p><b>g</b> = gravitational constant (32.2 ft/sec<sup>2</sup>)</p>

For design purposes, flood velocities in coastal areas should be assumed to lie between  $V = (gd_s)^{0.5}$  (the expected upper bound) and  $V = d_s/t$  (the expected lower bound), where  $g$  is the gravitational constant (32.2 ft/sec),  $d_s$  is the design stillwater flood depth, and  $t = \text{time} = 1$  sec. It is recommended that designers consider the following factors before selecting the upper- or lower-bound flood velocity for design:

- flood zone
- topography and slope
- distance from the source of flooding
- proximity to other buildings or obstructions

If the building site is near the flood source, in a V zone, in an AO zone adjacent to a V zone, in an A zone subject to velocity flow and wave action, steeply sloping, or adjacent to other buildings or obstructions that will confine flood waters and accelerate flood velocities, the upper bound should be taken as the design flood velocity. If the site is distant from the flood source, in an A zone, flat or gently sloping, or unaffected by other buildings or obstructions, the lower bound is a more appropriate design flood velocity.



### CROSS-REFERENCE

For information about tsunami forces, see Section 11.7 of this chapter.

In some extreme circumstances (e.g., near the shoreline in a tsunami inundation zone) flood velocities should be estimated as high as  $V = 2(gd_s)^{0.5}$ .

Figure 11-4 shows the velocity/design stillwater depth relationship for the upper- and lower-bound velocities. Formula 11.2 shows the equations for the lower-bound, upper-bound, and extreme velocity conditions.



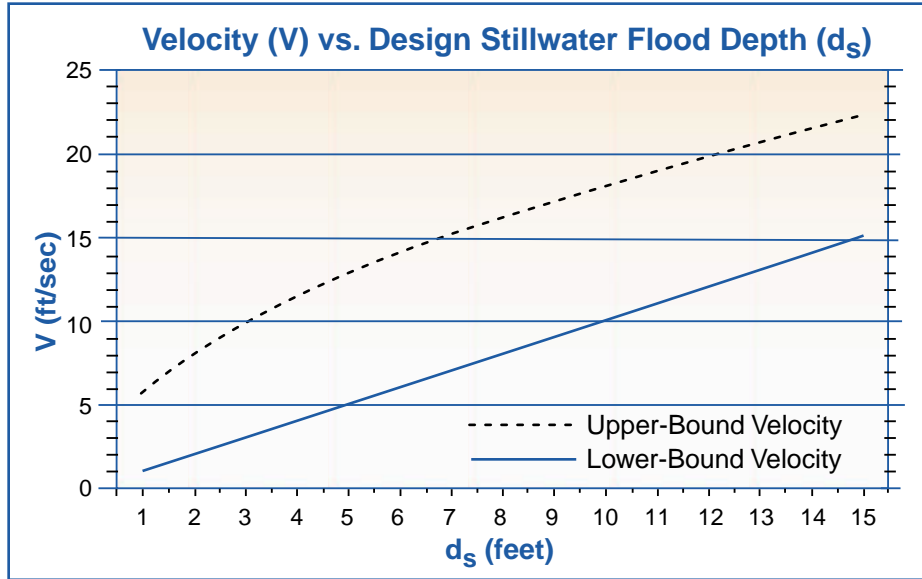

**Figure 11-4**  
Velocity vs. design stillwater flood depth in areas not subject to tsunamis. (For a comparison of non-tsunami and tsunami velocities vs. design stillwater depth, see Figure 11-16.)

### 11.6.7 Hydrostatic Loads

Hydrostatic loads occur when standing or slowly moving water comes into contact with a building or building component. Hydrostatic loads can act laterally or vertically, and the forces they exert include buoyant or flotation forces.

Lateral hydrostatic forces are generally not sufficient to cause deflection or displacement of a building or building component unless there is a substantial difference in water elevation on opposite sides of the building or component—hence, the National Flood Insurance Program (NFIP) requirement that flood water openings be provided in vertical walls that form an enclosed space below the BFE in an A zone building (see Chapter 6, Section 6.4.3.2).

Likewise, vertical hydrostatic forces are not generally a concern for properly constructed and elevated coastal buildings during design flood conditions. Buoyant or flotation forces on a building can be of concern if the actual stillwater flood depth exceeds the design stillwater flood depth. Buoyant forces are also of concern for empty aboveground and belowground tanks and for swimming pools.

Lateral hydrostatic forces are given by Formula 11.3 and are illustrated in Figure 11-5. Vertical hydrostatic forces are given by Formula 11.4 and are illustrated by Figure 11-6. Note that  $F_{sta}$  (in Formula 11.3) is equivalent to the area of the pressure triangle, and acts at a point equal to  $2/3 d_s$  below the water surface (see Figure 11-5).



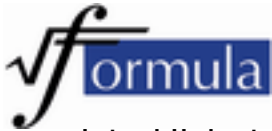

Lateral Hydrostatic Load

### Formula 11.3 Lateral Hydrostatic Load

$$f_{sta} = (1/2)\gamma d_s^2$$

where:

$f_{sta}$  = hydrostatic force per unit width (lb/ft) resulting from flooding against vertical element

$\gamma$  = specific weight of water (62.4 lb/ft<sup>3</sup> for fresh water and 64.0 lb/ft<sup>3</sup> for salt water)

$d_s$  = design stillwater flood depth in feet

$$F_{sta} = f_{sta}(w)$$

and

where:  $w$  = width of vertical element in feet

$F_{sta}$  = total equivalent lateral hydrostatic force on structure in lb

**Figure 11-5**  
Lateral flood force on a vertical component.

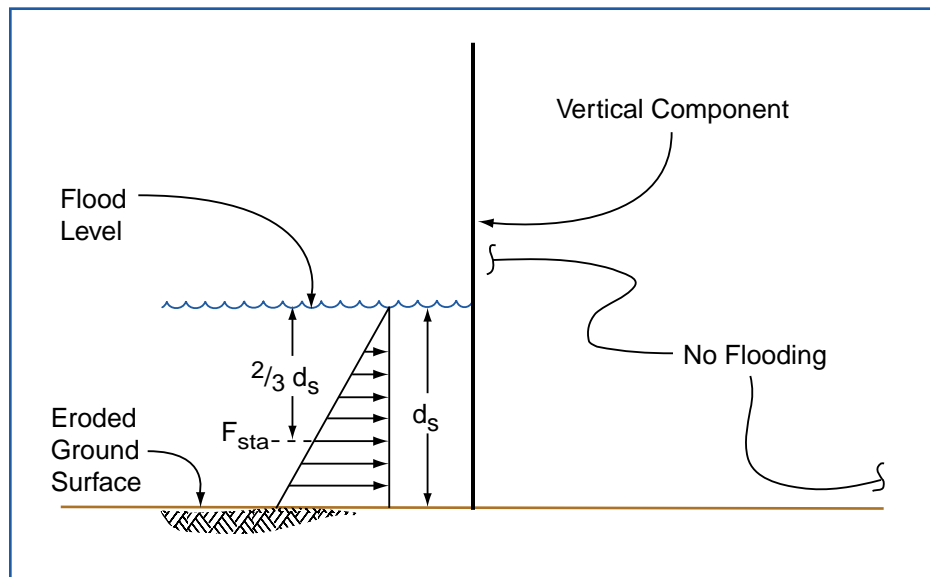

Figure 11-5 is presented here solely to illustrate the application of lateral hydrostatic force. In communities participating in the NFIP, local floodplain ordinances or laws require that buildings in V zones be elevated above the BFE on an open foundation and that the foundation walls of buildings in A zones be equipped with openings that allow flood water to enter so that internal and external hydrostatic pressures will equalize (see Chapter 6, Section 6.4.3.2).

**Formula 11.4 Vertical (Buoyant) Hydrostatic Force**

$$F_{\text{buoy}} = \gamma(\text{Vol})$$

where:  $F_{\text{buoy}}$  = vertical hydrostatic force in lb resulting from the displacement of a given volume of flood water

$\gamma$  = specific weight of water (62.4 lb/ft<sup>3</sup> for fresh water and 64.0 lb/ft<sup>3</sup> for salt water)

$\text{Vol}$  = volume of flood water displaced by a submerged object in ft<sup>3</sup>



Vertical (Buoyant) Hydrostatic Force

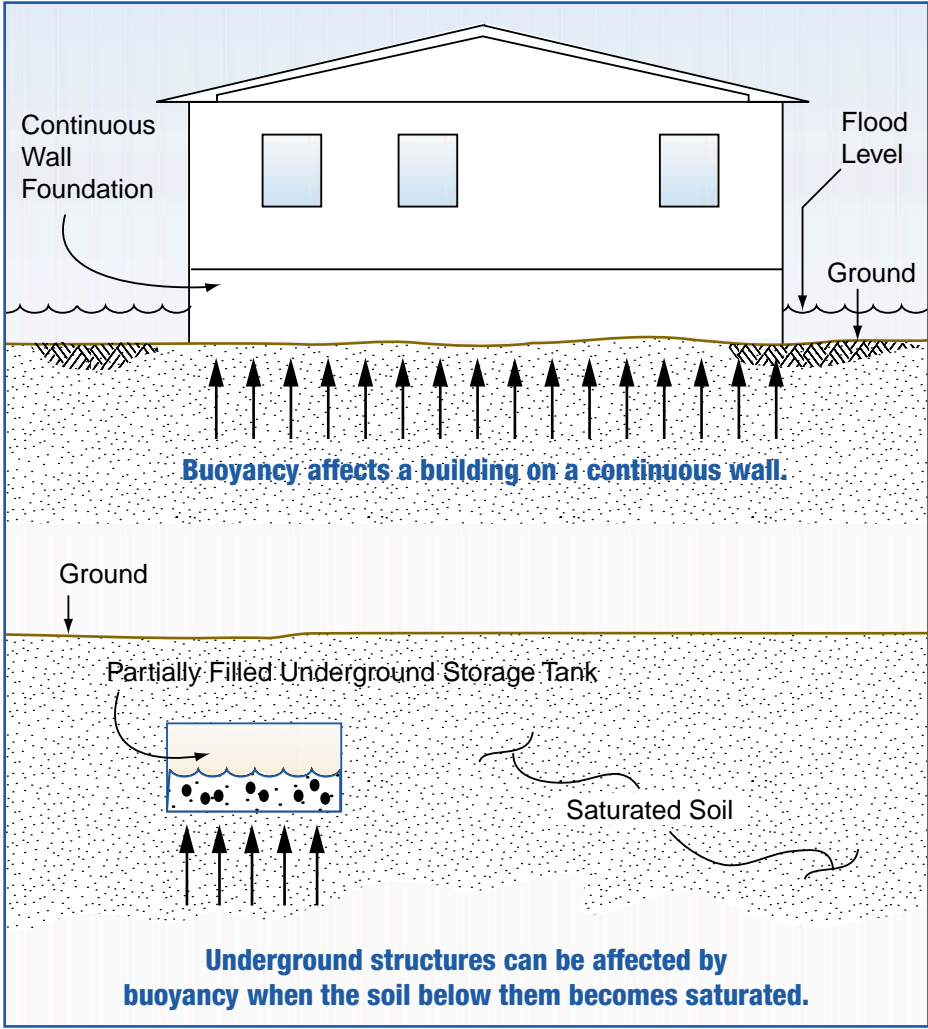

**Figure 11-6**  
Vertical (buoyant) flood force.

**NOTE**

Additional guidance for calculating wave loads is presented in ASCE 7-98 (ASCE 1998b).

Moving water exerts hydrodynamic loads (see Section 11.6.9), but where flow velocities do not exceed 10 ft/sec, the hydrodynamic loads can be converted to an equivalent hydrostatic force (see Formula 11.7 in Section 11.6.9).

Any buoyant force  $F_{\text{buoy}}$  on an object must be resisted by the weight of the object and any other opposing force (e.g., anchorage forces) resisting flotation. The contents of underground storage tanks and the live load on floors should not be counted on to resist buoyant forces since the tank may be empty or the house may be vacant when the flood occurs. Empty or partially empty tanks or pools are particularly vulnerable.

### 11.6.8 Wave Loads

Calculation of wave loads requires information about expected wave heights, which, for the purposes of this manual, will be limited by water depths at the site of interest. These data can be estimated with a variety of models – FEMA uses its Wave Height Analysis for Flood Insurance Studies (WHAFIS) model to estimate wave heights and wave crest elevations, and results from this model can be used directly by designers to calculate wave loads.

Wave forces can be separated into four categories:

- those from non-breaking waves (these forces can usually be computed as hydrostatic forces against walls and hydrodynamic forces against piles)
- those from breaking waves (these forces will be of short duration, but large magnitude)
- those from broken waves (these forces are similar to hydrodynamic forces caused by flowing or surging water)
- uplift (these forces are often caused by wave runup, deflection, or peaking against the underside of horizontal surfaces)

Of these, the forces from breaking waves are the highest and produce the most severe loads. **Therefore, this manual strongly recommends that the breaking wave load be used as the design wave load.**

Two breaking wave loading conditions are of interest in residential construction—waves breaking on small-diameter vertical elements below the DFE (e.g., piles, columns in the foundation of a building in a V zone) and waves breaking against walls below the DFE (e.g., solid foundation walls in A zones, breakaway walls in V zones). For information and comparative purposes, both loading conditions will be discussed.

### 11.6.8.1 Breaking Wave Loads on Vertical Piles

The breaking wave load on a pile can be assumed to act at the stillwater level and is calculated with Formula 11.5.

As noted previously, the wave loads produced by breaking waves are greater than those produced by non-breaking or broken waves. The following example shows the difference between the loads imposed on a vertical pile by non-breaking waves and breaking waves.

Formula 11.5 Breaking Wave Load on Vertical Piles	
	$F_{brkP} = (1/2) C_{db} \gamma D H_b^2$
where:	$F_{brkP}$ = drag force in lb acting at the stillwater level
	$C_{db}$ = breaking wave drag coefficient (recommended values are 2.25 for square or rectangular piles and 1.75 for round piles)
	$\gamma$ = specific weight of water (62.4 lb/ft <sup>3</sup> for fresh water and 64.0 lb/ft <sup>3</sup> for salt water)
	$D$ = pile diameter in feet
	$H_b$ = breaking wave height in feet ( $0.78d_s$ )
where:	$d_s$ = design stillwater flood depth in feet



### 11.6.8.2 Breaking Wave Loads on Vertical Walls

Breaking wave loads on vertical walls are best calculated according to the procedure outlined in *Criteria for Evaluating Coastal Flood-Protection Structures* (Walton, et. al 1989). This procedure is suitable for use in wave conditions typical during coastal flood and storm events. The relationship developed for breaking wave load per unit length of wall is shown in Formula 11.6.

The procedure assumes that the vertical wall causes a reflected or standing wave to form against the seaward side of the wall and that the crest of the wave reaches a height of  $1.2d_s$  above the stillwater elevation. The resulting dynamic, static, and total pressure distributions against the wall, and the resulting loads, are as shown in Figure 11-7.



Breaking Wave Load on Vertical Walls

**Formula 11.6 Breaking Wave Load on Vertical Walls**

Case 1 (enclosed dry space behind wall):

$$f_{brkw} = 1.1C_p\gamma d_s^2 + 2.41\gamma d_s^2$$

Case 2 (equal stillwater level on both sides of wall):

$$f_{brkw} = 1.1C_p\gamma d_s^2 + 1.91\gamma d_s^2$$

where:

$f_{brkw}$  = total breaking wave load per unit length of wall (lb/ft) acting at the stillwater level

$F_{brkw}$  = total breaking wave load (lb) acting at the stillwater level =  $f_{brkw} w$ , where  $w$  = width of wall in feet

$C_p$  = dynamic pressure coefficient from Table 11.1

$\gamma$  = specific weight of water (62.4 lb/ft<sup>3</sup> for fresh water and 64.0 lb/ft<sup>3</sup> for saltwater)

$d_s$  = design stillwater flood depth in feet

**Note:** Formula 11.6 includes the hydrostatic component calculated by Formula 11.3. If Formula 11.6 is used, **do not** add a lateral hydrostatic force from Formula 11.3.

**Table 11.1**  
Value of Dynamic Pressure Coefficient,  $C_p$ , as a Function of Probability of Exceedance (from Walton, et al. 1989)

$C_p$	Building Type	Probability of Exceedance
1.6	accessory structure, low hazard to human life or property in the event of failure	0.5
2.8	coastal residential building	0.01
3.2	high-occupancy building or critical facility	0.001

**Figure 11-7**  
Dynamic, static, and total pressure distributions against a vertical wall.

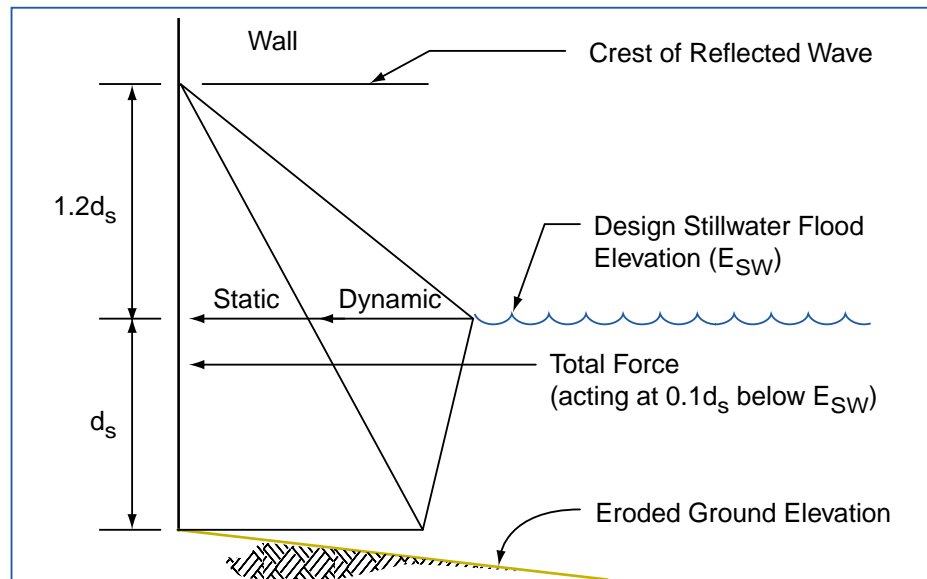

This procedure allows two cases to be considered: (1) where a wave breaks against a vertical wall of an enclosed dry space and (2) where the stillwater level on both sides of the wall is equal. Case 1 is equivalent to a situation where a wave breaks against an enclosure in which there is no floodwater below the stillwater level; Case 2 is equivalent to a situation in which a wave breaks against a breakaway wall or a wall equipped with openings that allow flood waters to equalize on both sides of the wall. In both cases, waves are normally incident (i.e., wave crests parallel to the wall). If breaking waves are obliquely incident (i.e., wave crests **not** parallel to the wall—see illustration at right), the calculated loads would be lower.

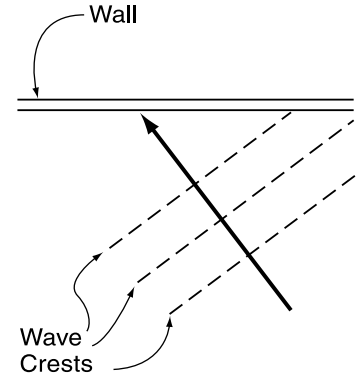

**Wave Crests Not Parallel to Wall**

Figure 11-8 shows, for Case 2, the relationship between water depth and wave height, and between water depth and breaking wave force for the 1-percent and 50-percent exceedance interval events. By comparison, the Case 1 breaking wave forces would be approximately 1.1 times those shown for these two events.

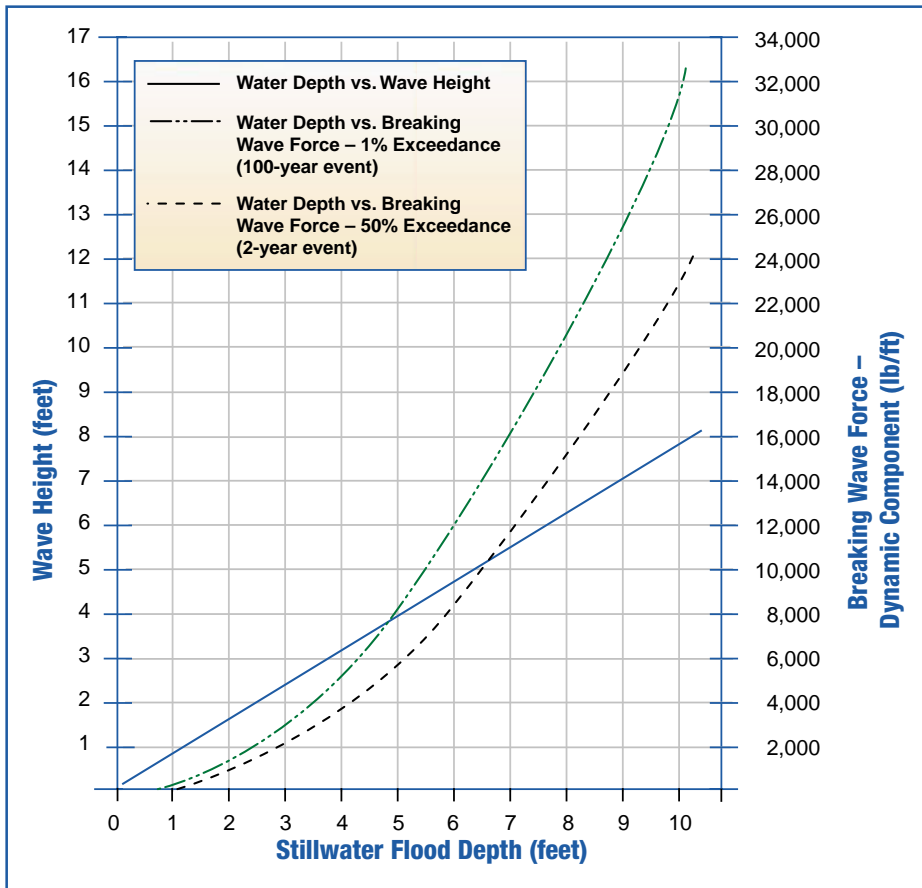

**Figure 11-8** Water depth vs. wave height, and water depth vs. breaking wave force against a vertical wall (for Case 2, with stillwater behind the wall) for the 1-percent and 50-percent exceedance interval events.



## WARNING

Even waves less than 3 feet high can impose large loads on foundation walls. This manual recommends that buildings in coastal A zones be designed and constructed to meet V-zone requirements (see Section 6.5.2 in Chapter 6).



## WARNING

Under the NFIP, construction of solid foundation walls (such as those shown in Figure 11-9) for new, substantially damaged, and substantially improved buildings is not permitted in V zones.

It is important to note that the wave pressures shown in Figure 11-8 are much higher than typical wind pressures that act on a coastal building, even wind pressures that occur during a hurricane or typhoon. However, the duration of the wave pressures and loads is brief; peak pressures probably occur within 0.1 to 0.3 second after the wave breaks against the wall (see papers contained in *Wave Forces on Inclined and Vertical Wall Surfaces* [ASCE 1995] for a detailed discussions on breaking wave pressures and durations).

Post-storm damage inspections show that breaking wave loads have destroyed virtually all wood-frame or unreinforced masonry walls below the wave crest elevation—only highly engineered, massive structural elements are capable of withstanding breaking wave loads. It is important to note that damaging wave pressures and loads can be generated by waves much lower than the 3-foot wave currently used by FEMA to distinguish between A zones and V zones. This fact was confirmed by the results of recent FEMA-sponsored laboratory tests of breakaway wall failures, in which measured pressures on the order of hundreds of lb/ft<sup>2</sup> were generated by waves 12–18 inches high. The test results are presented in FEMA NFIP Technical Bulletin 9 (see Appendix H).

### 11.6.9 Hydrodynamic Loads

Water flowing around a building (or a structural element or other object) imposes additional loads on the building as shown in Figure 11-9. The loads (which are a function of flow velocity and structure geometry) include frontal impact on the upstream face, drag along the sides, and suction on the downstream side. This manual assumes that the velocity of the flood waters is constant (i.e., steady state flow) and, as noted previously, that the hydrodynamic load imposed by flood waters moving at less than 10 ft/sec can be converted to an equivalent hydrostatic load (USACE 1992, ASCE 1998b).

**Figure 11-9**

Hydrodynamic loads on a building. Note that the lowest floor of the building shown here is above the flood level and that the loads imposed by flowing water affect only the foundation walls.

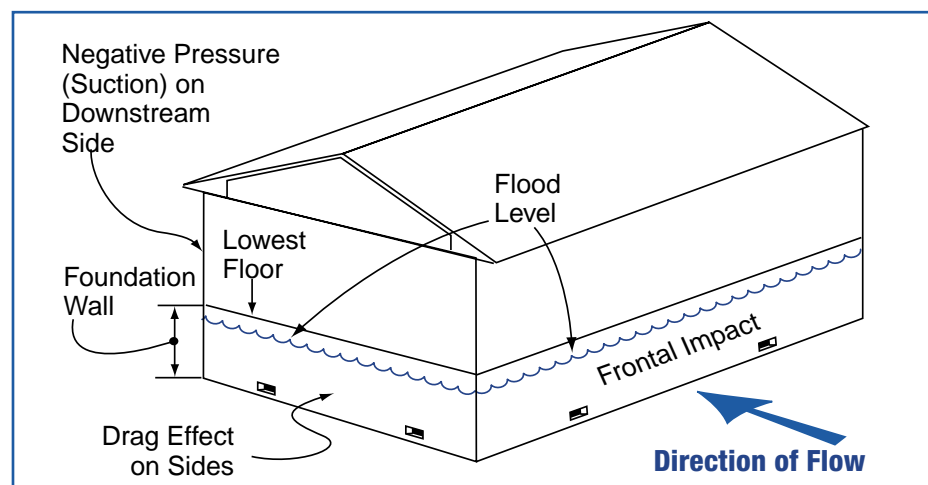

One of the most difficult steps in quantifying loads imposed by moving water is determining the expected flood velocity. Refer to Formula 11.2 in Section 11.6.6 for guidance concerning design flood velocities.

The equivalent hydrostatic load imposed by water moving at less than 10 ft/sec is calculated with Formula 11.7

Formula 11.7 Hydrodynamic Load	
(flow velocity less than 10ft/sec)	
$d_{dyn} = (1/2) C_d V^2/g$	
where:	<p><math>d_{dyn}</math> = equivalent additional flood depth to be applied to the upstream side of the affected structure, in feet</p> <p><math>V</math> = velocity of water in ft/sec (see Formula 11.2)</p> <p><math>g</math> = acceleration due to gravity (32.2 ft/sec<sup>2</sup>)</p> <p><math>C_d</math> = drag coefficient (recommended values are 2.0 for square or rectangular piles and 1.2 for round piles, or from Table 11.2 for larger obstructions)</p>
and	
$f_{dyn} = \gamma d_s d_{dyn}$	
where:	<p><math>f_{dyn}</math> = equivalent hydrostatic force per unit width (lb/ft) due to low-velocity flow acting at the point 2/3 below the stillwater surface of the water</p> <p><math>\gamma</math> = specific weight of water (62.4 lb/ft<sup>3</sup> for fresh water and 64.0 lb/ft<sup>3</sup> for saltwater)</p>
and	
$F_{dyn} = f_{dyn}(w)$	
where:	<p><math>F_{dyn}</math> = total equivalent lateral hydrostatic force in lb acting at the point 2/3 below the stillwater surface of the water</p> <p><math>w</math> = width of structure in feet</p>

 **Formula**  
 Hydrodynamic Load  
 From Flood Flows  
 Moving at Less Than  
 10 ft/sec



**CROSS-REFERENCE**  
 For guidance regarding drag coefficients ( $C_d$ ), refer to Volume II of the U.S. Army Corps of Engineers *Shore Protection Manual* (USACE 1984), Section 5.3.3 of ASCE 7-98 (ASCE 1998b), and FEMA 259 (FEMA 1995a).

The drag coefficient used in the above equation is taken from the U.S. Army Corps of Engineers *Shore Protection Manual*, Volume II (USACE 1984). Additional guidance is provided in Section 5.3.3 of ASCE 7-98 (ASCE 1998b) and in FEMA 259 (FEMA 1995a).

The drag coefficient is a function of the shape of the object around which flow is directed. When the object is something other than a round, square, or rectangular pile, the coefficient is determined by one of the following ratios:

1. the ratio of the width of the object ( $w$ ) to the height of the object ( $h$ ), if the object is completely immersed in water



**NOTE**

Lift coefficients ( $C_l$ ) can be found in *Introduction to Fluid Mechanics* (Fox and McDonald 1985) and in many other fluid mechanics textbooks.



- the ratio of the width of the object ( $w$ ) to the stillwater depth of the water ( $d_s$ ), if the object is not fully immersed (see Figure 11-10 and Table 11.2)

**Figure 11-10**  
 Determining drag coefficient from width-to-depth ratio. Note that the lowest floor of the building shown here is above the flood level.

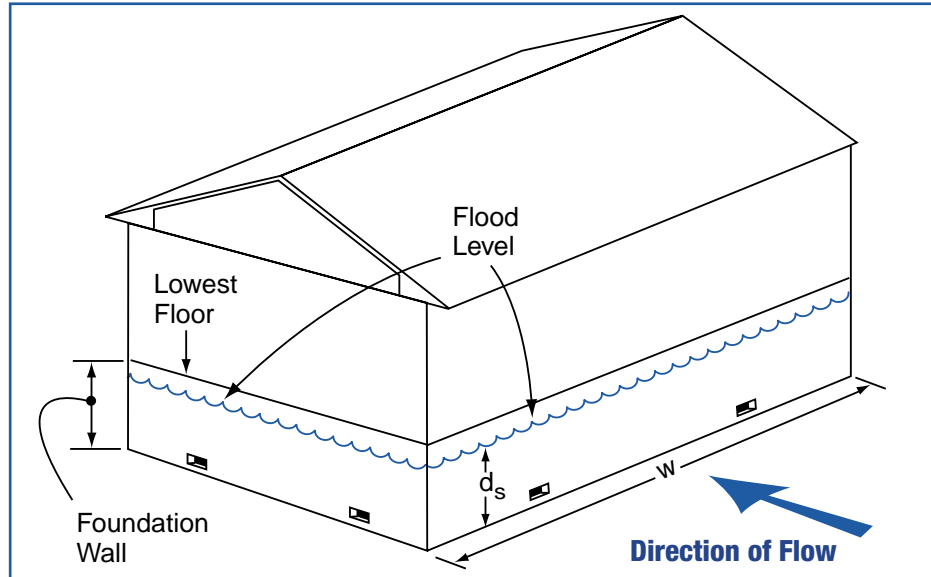

**Table 11.2**  
 Drag Coefficients for Ratios of Width to Depth ( $w/d_s$ ) and Width to Height ( $w/h$ )

Width to Depth Ratio ( $w/d_s$ or $w/h$ )	Drag Coefficient $C_d$
From 1 – 12	1.25
13 – 20	1.3
21 – 32	1.4
33 – 40	1.5
41 – 80	1.75
81 – 120	1.8
>120	2.0

Flow around a building or building component will also create flow-perpendicular forces (lift forces). When the building component is rigid, lift forces can be assumed to be small. When the building component is not rigid, lift forces can be greater than drag forces. The formula for lift force is the same as that for hydrodynamic force except that the drag coefficient,  $C_d$ , is replaced with the lift coefficient,  $C_l$ . For the purposes of this manual, the foundations of coastal residential buildings can be considered rigid, and hydrodynamic lift forces can therefore be ignored.

The hydrodynamic loads imposed by flood waters with velocities greater than 10 ft/sec cannot be converted to equivalent hydrostatic loads. Instead, they must be determined according to the principles of fluid mechanics or hydraulic models (see Formula 11.8).

Formula 11.8 Hydrodynamic Load	
<b>(flow velocity greater than 10ft/sec)</b>	
<b><math>F_{dyn} = (1/2) C_d \rho V^2 A</math></b>	
where:	<p><b><math>F_{dyn}</math></b> = horizontal drag force in lb acting at the stillwater mid-depth (half-way between the stillwater elevation and the eroded ground surface)</p> <p><b><math>C_d</math></b> = drag coefficient (recommended values are 2.0 for square or rectangular piles and 1.2 for round piles, or from Table 11.2 for larger obstructions)</p> <p><b><math>\rho</math></b> = mass density of fluid (1.94 slugs/ft<sup>3</sup> for fresh water and 1.99 slugs/ft<sup>3</sup> for salt water)</p> <p><b><math>V</math></b> = velocity of water in ft/sec (see Formula 11.2)</p> <p><b><math>A</math></b> = surface area of obstruction normal to flow in ft<sup>2</sup> = <math>w d_s</math> (see Figure 11-10) or <math>wh</math></p>



Hydrodynamic Load  
From Flood Flows  
Moving at Greater  
Than 10 ft/sec

Note that the use of this formula will provide the total force against a building of a given impacted surface area  $A$ . Dividing the total force by either length or width would yield a force per linear unit; dividing by  $A$  would yield a force per unit area. Also, note that the drag coefficients for square, rectangular, and round piles in Formula 11.8 ( $C_d$ ) are lower than those in Formula 11.5 ( $C_{db}$ ).



Non-Breaking Wave  
Load on Piles vs.  
Breaking Wave Load  
on Piles



### NOTE

Treat non-breaking wave loads  
as hydrodynamic loads.

### Example: Non-Breaking Wave Load on Piles vs. Breaking Wave Load on Piles

The following conditions are assumed:

- house elevated on round-pile foundation near saltwater
- $C_d$  (drag coefficient for non-breaking wave on round pile – see Formula 11.7) = 1.2
- $C_{db}$  (drag coefficient for breaking wave on round pile – see Formula 11.5) = 1.75
- $D = 10$  in or 0.833 foot
- $d_s = 8$  feet
- Velocity ranges from 8 ft/sec to 16 ft/sec
- $\rho =$  mass density of water (1.94 slugs/ft<sup>3</sup> for fresh water and 1.99 slugs/ft<sup>3</sup> for salt water)
- $A = (8 \text{ ft})(0.833 \text{ ft})$

The load from a non-breaking wave on a pile is calculated as follows:

$$F_{\text{nonbrkp}} = (1/2)C_d\rho V^2A \text{ so}$$

$$F_{\text{nonbrkp}} = 509 \text{ lb /pile to } 2,038 \text{ lb/pile (depending on flood velocity)}$$

The load from a breaking wave on a pile is calculated with Formula 11.5:

$$F_{\text{brkp}} = (1/2)C_{db}\gamma D H_b^2 \text{ where } H_b \text{ is the height of the breaking wave or } (0.78)(d_s) \text{ so}$$

$$F_{\text{brkp}} = 1,810 \text{ lb /pile}$$

**NOTE:** The load from the breaking wave is approximately 3.5 times the lower estimate of the non-breaking wave load. The upper estimate of the non-breaking wave load exceeds the breaking wave load only because of the very conservative nature of the upper flood velocity estimate.

### 11.6.10 Debris Impact Loads

Debris or impact loads are imposed on a building by objects carried by moving water. The magnitude of these loads is very difficult to predict, yet some reasonable allowance must be made for them. The loads are influenced by where the building is in the potential debris stream:

- immediately adjacent to or downstream from another building
- downstream from large floatable objects (e.g., exposed or minimally covered storage tanks)
- among closely spaced buildings

The equation normally used for the calculation of debris loads is an expression for momentum and is given by Formula 11.9.

**Formula 11.9 Debris Impact Load**

$$F_i = wV/gt$$

where:	$F_i$ = impact force in lb acting at the stillwater level
	$w$ = weight of the object in lb
	$V$ = velocity of water in ft/sec or approximated by $1/2(gd_s)^{1/2}$
	$g$ = gravitational constant (32.2 ft/sec <sup>2</sup> )
	$t$ = duration of impact in seconds



Debris Impact Load

This equation contains several uncertainties, each of which must be quantified before the impact of debris loading on the building can be determined:

- size, shape, and weight ( $w$ ) of the waterborne object
- flood velocity ( $V$ )
- velocity of the object compared to the flood velocity
- portion of the building that will be struck and the most vulnerable portion of the building where failure could mean collapse
- duration of the impact ( $t$ )

**Size, shape, and weight of the debris**

Although difficult to generalize, there may be regional differences in debris types. For example, the coasts of Washington, Oregon, and selected other areas may be subject to very large debris in the form of logs present along the shoreline. Other areas, such as the southeast coast of the United States, may be more subject to debris impact from dune crossovers, destroyed buildings, and the like. It is recommended that in the absence of information about the nature of the potential debris, a weight of 1,000 lb be used for the value of  $w$ . Objects of this weight could include portions of damaged buildings, utility poles, portions of previously embedded piles, and empty storage tanks.

**Debris Velocity**

As noted in Section 11.6.6, flood velocity can be approximated by one of the equations in Formula 11.2; refer to that section for a discussion of how to choose the most appropriate equation. For the calculation of debris loads, the velocity of the waterborne object is assumed to be the same as the flood velocity. Note that although this assumption may be accurate for small objects, it will overstate debris velocities for large objects.

**NOTE**

The assumption that debris velocity is equal to flood velocity may overstate the velocities of large debris objects; therefore, engineering judgment may be required in some instances. Designers may wish to reduce debris velocity for larger objects.

**Portion of building to be struck**

The object is assumed to be at or near the water surface level when it strikes the building. Therefore, the object is assumed to strike the building at the stillwater level.

**Duration of impact**

Uncertainty about the duration of impact ( $t$ )—the time from initial impact, through the maximum deflection caused by the impact, to the time the object leaves—is the most likely cause of error in the calculation of debris impact loads. According to physics and dynamics texts such as Chopra (1995), the duration of impact is influenced primarily by the natural frequency of the building, which is a function of the building's "stiffness." This stiffness is determined by the properties of the material being struck by the object, the number of supporting members (columns or piles), the height of the building above the ground, and the height at which the material is struck.

Although little guidance on duration of impact exists, the City of Honolulu Building Code recommends the following durations based on the type of construction being struck:

- wood: 1 second
- steel: 0.5 second
- reinforced concrete: 0.1 second

The graphs in Figure 11-11 show deflection vs. duration of impact ( $t$ ) for several scenarios involving debris impact on one wood pile in each of four pile foundation examples. The largest deflection is for a mass ( $M$ ) supported by only two piles 8 feet above grade (scenario  $M/8/2$  in the figure). For five piles supporting twice that mass 4 feet above grade (scenario  $2M/4/5$  in the figure), the deflection is very small. The other deflection scenarios shown in Figure 11-11 are a mass ( $M$ ) supported by five piles 8 feet above grade ( $M/8/5$ ) and five piles supporting twice the mass 8 feet above grade ( $2M/8/5$ ).

A complete mathematical analysis of this problem is beyond the scope of this manual; however, Table 11.3 suggests durations ( $t$ ) to use in Formula 11.9. These durations were developed with a mathematical model from dynamic theory. They are of approximately the same order of magnitude as those provided in the City of Honolulu Building Code.

Figure 11-11 Pile deflection vs. duration of impact (t) for alternative wood pile foundations.

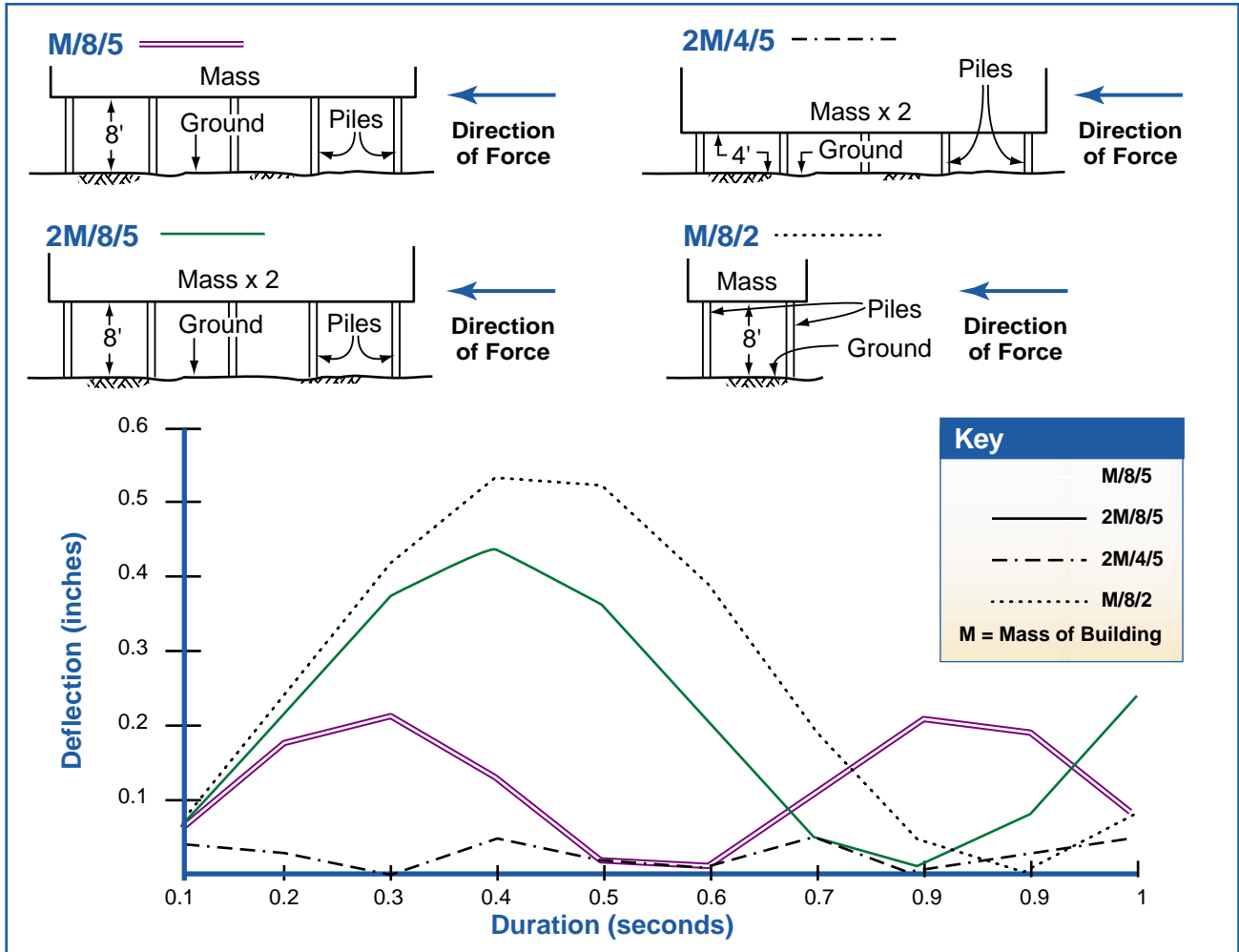

Type of Construction	Duration (t) of Impact (sec)	
	Wall	Pile
Wood	0.7 – 1.1	0.5 – 1.0
Steel	NA	0.2 – 0.4
Reinforced Concrete	0.2 – 0.4	0.3 – 0.6
Concrete Masonry	0.3 – 0.6	0.3 – 0.6

Table 11.3 Impact Durations (t) for Use in Formula 11.9

NA - Not Applicable

### 11.6.11 Localized Scour

Waves and currents during coastal flood conditions are capable of creating turbulence around foundation elements, and causing localized scour around those elements. Determining potential scour is critical in designing coastal foundations to ensure that failure during and after flooding does not occur as a result of the loss in either bearing capacity or anchoring resistance around the posts, piles, piers, columns, footings, or walls. Localized scour determinations will require knowledge of the flood depth, flow conditions, soil characteristics, and foundation type.

In some locations, soil at or below the ground surface can be resistant to localized scour, and scour depths calculated below will be excessive. In instances where the designer believes the soil at a site will be scour-resistant, the assistance of a geotechnical engineer should be sought before calculated scour depths are reduced.

#### 11.6.11.1 Localized Scour Around Vertical Piles (Non-Tsunami Condition)

Localized scour calculation methods in coastal areas have been largely based on empirical evidence gathered after storms. This evidence suggests that localized scour depths around piles and other thin vertical members are approximately equal to 1.0 to 1.5 times the pile diameter. Figure 11-12 illustrates localized scour at a pile, with and without a scour-resistant terminating stratum. Until such time as better design guidance is obtained, localized scour around a vertical pile or similar foundation element should be calculated with Formula 11.10a.

**Figure 11-12**  
Scour at vertical foundation member stopped by underlying scour-resistant stratum.

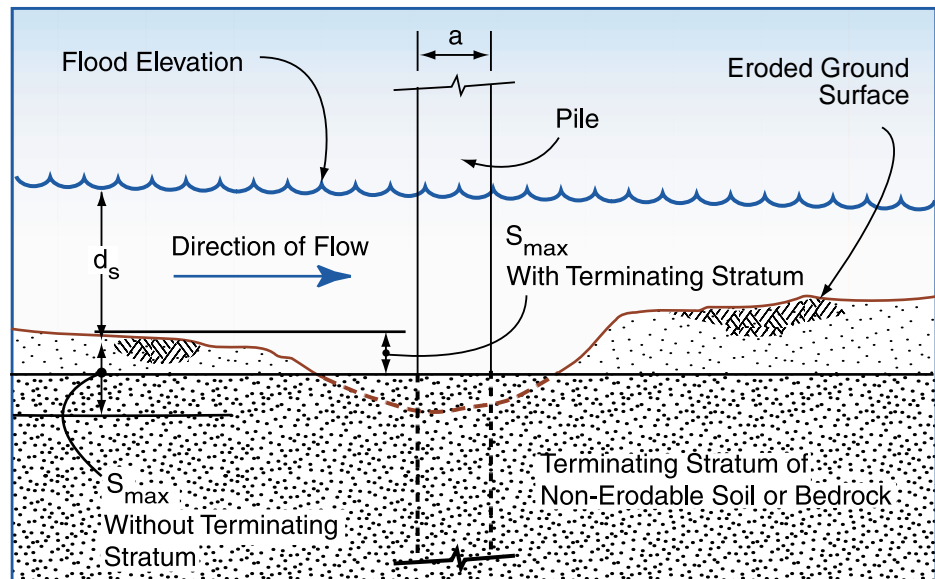

**Formula 11.10a Localized Scour Around Vertical Pile**  
(Non-Tsunami Condition)

$$S_{max} = 2.0a$$

where:  $S_{max}$  = maximum localized scour depth in feet  
 $a$  = diameter of a round foundation element, or the maximum diagonal cross-section dimension for a rectangular element



Localized Scour Around Vertical Pile (Non-Tsunami Condition)



**NOTE**

Formula 11.10a can also be used to approximate local scour beneath grade beams—set “a” equal to the depth (vertical thickness) of the grade beam.

**11.6.11.2 Localized Scour Around Vertical Walls and Enclosures (Non-Tsunami Condition)**

Localized scour around vertical walls and enclosed areas (e.g., typical A-zone construction) can be greater than that around vertical piles, and should be calculated with Formula 11.10b.

**Formula 11.10b Localized Scour Around Vertical Enclosure**  
(Non-Tsunami Condition)

$$S_{max} = d_s \{2.2(a/d_s)^{0.65}[V/(gd_s)^{0.50}]^{0.43}\}K$$

where:  $S_{max}$  = maximum localized scour depth in feet  
 $d_s$  = design stillwater flood depth in feet (upstream of the structure)  
 $a$  = half the width of the solid foundation perpendicular to the flood flow  
 $V$  = average velocity of water in ft/sec (see Formula 11.2)  
 $g$  = gravitational constant (32.2 ft/sec<sup>2</sup>)  
 $K$  = factor applied for Flow Angle of Attack (see Table 11.4)



Localized Scour Around Vertical Enclosure (Non-Tsunami Condition)



**WARNING**

Formula 11.10b was developed by hydraulic engineers to estimate local scour around bridge piers in rivers. Its use in coastal areas is suggested as an interim method until a better method is developed. **Scour depths estimated with Formula 11.10b can be unrealistically high for coastal areas and should be capped at 10 feet of localized scour.**



**WARNING**

Formula 11.10b is not applicable to new, substantially damaged, and substantially improved buildings in V zones, because the NFIP-compliant floodplain management laws or ordinances enacted by communities require the use of open foundations for such buildings.



The magnitude of local scour at thin vertical members is not affected by the direction of flow, because the cross-sectional dimensions of such members are uniform or nearly uniform. However, the magnitude of scour at a wall of a building will vary with the angle at which the water strikes the wall. If the wall is not perpendicular to the direction of flow, a multiplying factor **K** should be applied to Formula 11.10b to account for the resulting increase in scour (see Table 11.4). As shown in the table, the value of **K** varies with not only the angle of attack, but also the width/length ratio of the building (see figure at left of Table 11.4).

**Table 11.4**  
Scour Factor for Flow Angle of Attack, **K** (Angle = 0 corresponds to flow perpendicular to building face.)

Angle of Attack (degrees)	Width/Length Ratio of Building in Flow			
	4	8	12	16
0	1	1	1	1
15	1.15	2	2.5	3
30	2	2.5	3.5	4.5
45	2.5	3.5	3.5	5
60	2.5	3.5	4.5	6

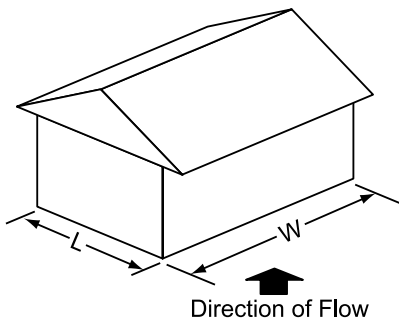

**11.6.11.3 Localized Scour (Tsunami Conditions)**

Dames and Moore, in *Design and Construction Standards for Residential Construction in Tsunami-Prone Areas of Hawaii* (1980), suggest that scour depth depends on soil type and that scour depths in areas up to 300 feet from the shoreline can be determined as a percentage of the stillwater depth  $d_s$ , as shown in Table 11.5.

**Table 11.5**  
Localized Scour Depth vs. Soil Type (From Dames & Moore 1980), Tsunami Conditions

Soil Type	Expected Depth (% of $d_s$ )
Loose sand	80%
Dense sand	50%
Soft silt	50%
Stiff silt	25%
Soft clay	25%
Stiff clay	10%

### 11.6.12 Flood Load Combinations

Designers should be aware that not all of the flood loads described in Section 11.6 will act at certain locations or against certain building types. Therefore, Table 11.6 provides guidance to designers for the calculation of appropriate flood loads in V zones and coastal A zones (non-coastal A zone flood load combinations are shown for comparison).

<b>Case 1:</b>	<b>Pile or Open Foundation in V Zone (Required)</b>
$F_{brkp}$ (on all piles, Formula 11.5) + $F_i$ (on one corner or critical pile only, Formula 11.9) or $F_{brkp}$ (on front row of piles only, Formula 11.5) + $F_{dyn}$ (on all piles but front row, Formula 11.7 or 11.8) + $F_i$ (on one corner or critical pile only, Formula 11.9)	
<b>Case 2:</b>	<b>Pile or Open Foundation in Coastal A Zone (Recommended)</b>
$F_{brkp}$ (on all piles, Formula 11.5) + $F_i$ (on one corner or critical pile only, Formula 11.9) or $F_{brkp}$ (on front row of piles only, Formula 11.5) + $F_{dyn}$ (on all piles but front row, Formula 11.7 or 11.8) + $F_i$ (on one corner or critical pile only, Formula 11.9)	
<b>Case 3:</b>	<b>Solid (Wall) Foundation in Coastal A Zone (NOT Recommended)</b>
$F_{brkw}$ (on walls facing shoreline, Formula 11.6, including hydrostatic component) + $F_{dyn}$ (Formula 11.7 or 11.8); assume one corner is destroyed by debris, and design in redundancy	
<b>Case 4:</b>	<b>Solid (Wall) Foundation in Non-Coastal A Zone (shown for comparison)</b>
$F_{sta}$ (Formula 11.3 and 11.4) + $F_{dyn}$ (Formula 11.7 or 11.8)	

**Table 11.6**  
Selection of Flood Load Combinations for Design



**NOTE**

- $F_{sta}$  = hydrostatic load
- $F_{dyn}$  = hydrodynamic load
- $F_i$  = debris impact load on pile
- $F_{brkp}$  = breaking wave load on pile
- $F_{brkw}$  = breaking wave load on wall

As noted in Chapter 6, the floodplain management regulations enacted by communities that participate in the NFIP prohibit the construction of solid perimeter wall foundations in V zones, but allow such foundations in A zones. Therefore, the designer should assume that breaking waves will impact piles in V zones and walls in A zones. It is generally unrealistic to assume that impact loads will occur on all piles at the same time as breaking wave loads; therefore, this manual recommends that impact loads be evaluated for strategic locations such as a building corner.



Example

## Flood Load Example Problem

### Given:

1. Oceanfront building site on landward side of a primary frontal dune (see Figure 11-13).
2. Topography along transect perpendicular to shoreline is shown in Figure 11-14; existing ground elevation at seaward row of pilings = 7.0 feet NGVD.
3. Soil is dense sand; no terminating stratum above -25 feet NGVD.
4. Data from FIRM is as follows: flood hazard zone at site is VE, BFE = 14.0 feet NGVD.
5. Data from FIS is as follows: 100-year stillwater elevation = 10.1 feet NGVD, 10-year stillwater elevation = 5.0 feet NGVD.
6. Local government requires 1.0 feet freeboard; therefore DFE = 14.0 feet NGVD (BFE) + 1.0 foot = 15.0 feet NGVD.
7. Building to be supported on 8-inch x 8-inch square piles as shown in Figure 11-15.
8. Direction of wave and flow approach during design event is perpendicular to shoreline (as shown in Figure 11-15).

### Find:

1. primary frontal dune reservoir; determine whether dune will be lost or provide protection during design event
2. eroded ground elevation beneath building resulting from storm erosion
3. design flood depth ( $d_s$ ) at seaward row of piles
4. probable range of design event flow velocities
5. local scour depth ( $S$ ) around seaward row of piles
6. design event breaking wave height ( $H_b$ ) at seaward row of piles
7. hydrodynamic (velocity flow) loads ( $F_{dyn}$ ) on a pile (not in seaward row)
8. breaking wave loads ( $F_{brk}$ ) on the seaward row of piles
9. debris impact load ( $F_i$ ) from a 1,000-lb object acting on one pile



# Example Flood Load Example Problem (continued)

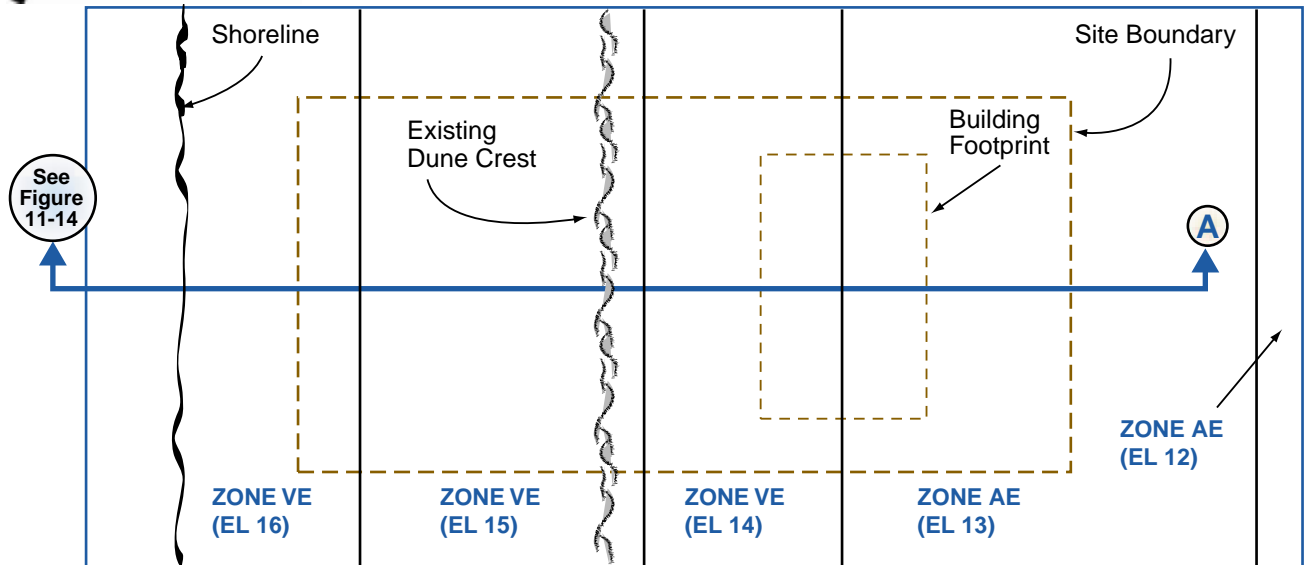

**Figure 11-13**  
Plan view of site and building location, with flood hazard zones.

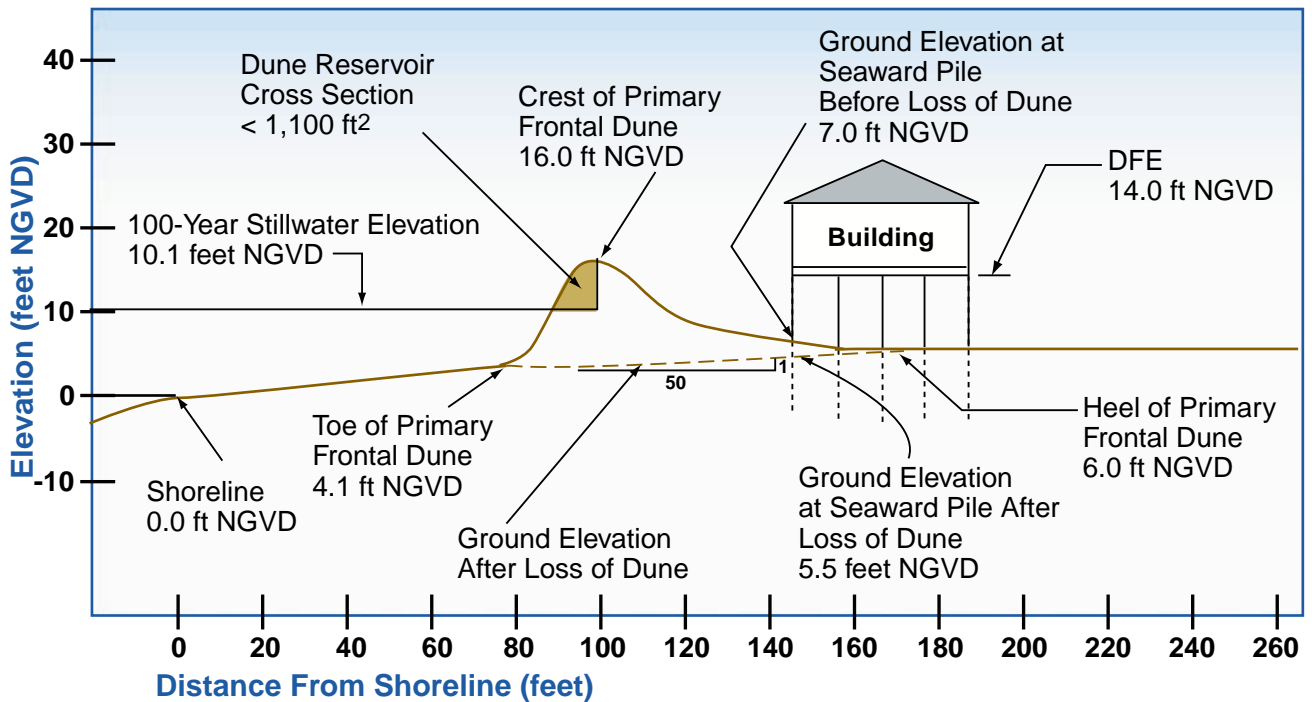

**Figure 11-14**  
Section A: Primary frontal dune will be lost to erosion during 100-year flood because dune reservoir is less than 1,100 ft<sup>2</sup>.



## Flood Load Example Problem (continued)

### 1 Primary frontal dune reservoir:

The cross-sectional area of the frontal dune reservoir is the area above 100-year stillwater elevation and seaward of dune crest. This area (see Figure 11-14) is approximately triangular, 5.9 feet high (16 feet NGVD dune crest elevation – 10.1 feet NGVD 100-year stillwater elevation), and approximately 15 feet wide at the base. This area will be slightly greater than the triangular area ( $1/2 \times 15 \text{ feet} \times 5.9 \text{ feet} = 44 \text{ ft}^2$ , **say 50 ft<sup>2</sup>**). This is far less than the 1,100 ft<sup>2</sup> required by this manual for dune to survive the 100-year event. **Therefore, assume the dune will be lost and provide no protection during 100-year event.**

### 2 Eroded ground elevation beneath building:

Remove dune from transect (see Section 7.8.1.4 and Figure 7-63, in Chapter 7) by drawing an upward-sloping (1:50 v:h) line, landward from the lower of the dune toe or the intersection of the 10-year stillwater elevation and the pre-storm profile. In this instance, the dune toe is lower (4.1 feet NGVD vs. 5.0 feet NGVD). Therefore, draw a line from the dune toe (located 75 feet from the shoreline, at the elevation 4.1 feet NGVD) sloping upward at a 1:50 (v:h) slope. The seaward row of piles (located at a point 145 feet from the shoreline) intersects this line at an elevation of 5.5 feet NGVD ( $4.1 \text{ feet NGVD} + [145-75][1/50]$ ). **The eroded ground elevation at the seaward row of pilings = 5.5 feet NGVD (neglecting local scour around the piles).**

### 3 Design stillwater flood depth ( $d_s$ ) at seaward row of pilings:

$d_s = 100\text{-year stillwater elevation} - \text{eroded ground elevation beneath building}$

So  $d_s = 10.1 \text{ feet NGVD} - 5.5 \text{ feet NGVD}$

**$d_s = 4.6 \text{ ft}$**

### 4 Range of design flow velocities ( $V$ ):

Lower  $V = \text{design stillwater flood depth (in feet)} / t$

Where:  $t = 1 \text{ sec}$

**Lower  $V = 4.6 \text{ ft/sec}$**

Upper  $V = (gd_s)^{0.5}$

Where:  $g = 32.2 \text{ ft/sec}^2$

$d_s = 4.6 \text{ ft}$

So upper  $V = (32.2 \times 4.6)^{0.5}$

**Upper  $V = 12.2 \text{ ft/sec}$**

### 5 Local scour depth ( $S$ ) around seaward row of pilings:

$S = 2.0a$  (from reduction of Formula 11.10a, see Section 11.6.11.1)

Where:  $a = \frac{\sqrt{7.5^2 + 7.5^2} \text{ in}}{12 \text{ in/ft}} = \frac{10.6 \text{ in}}{12 \text{ in/ft}} = 0.88 \text{ ft}$

So  $S = (2.0)(0.88)$

**$S = 1.76 \text{ ft}$**

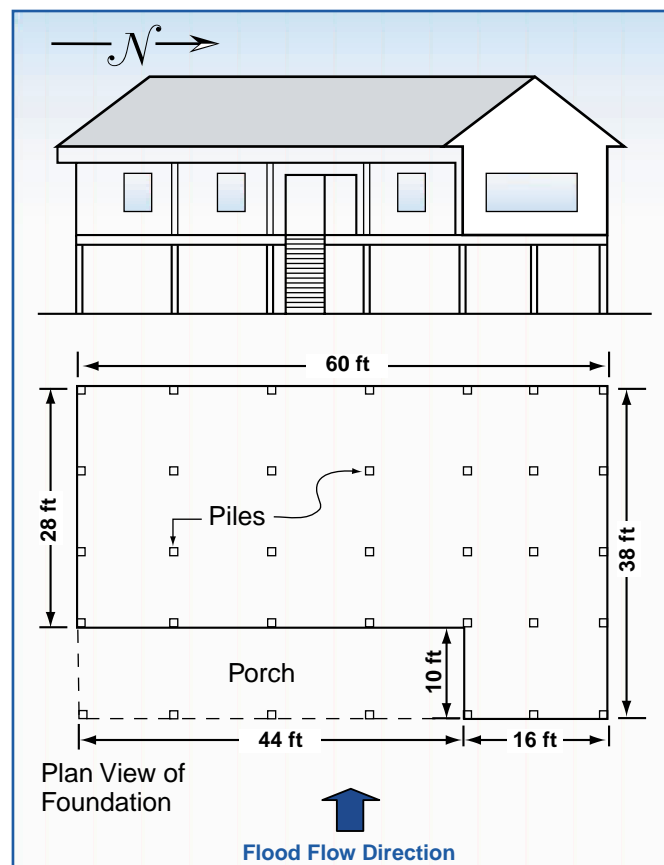

**Figure 11-15**  
Building elevation and plan view of pile foundation.



## Example Flood Load Example Problem (continued)

### 6 Breaking wave height ( $H_b$ ) at seaward row of pilings:

At seaward row of pilings,  $H_b = (\text{stillwater elevation} - \text{eroded ground elevation})(0.78)$

So  $H_b = (10.1 - 5.5)(0.78)$

**$H_b = 3.6$  ft**

### 7 Hydrodynamic (velocity flow) loads $F_{dyn}$ on a pile (not in seaward row):

$F_{dyn}$  on one pile =  $(1/2)C_d\rho V^2A$

Where:  $C_d = 2.0$  for a square pile

$\rho = 1.99$  slugs/ft<sup>3</sup>

$A = (8 \text{ in} / 12 \text{ in})(10.1 - 5.5) = 3.07 \text{ ft}^2$

Because building is on oceanfront, use upper flow velocity for calculating loads ( $V = 12.2$  ft/sec)

So  $F_{dyn} = (1/2)(2.0)(1.99)(12.2)^2(3.07)$

**$F_{dyn}$  on one pile = 909 lb**

Number of piles in seaward row = 7

$F_{dyn}$  on all but seaward row of piles =  $(909)(24) = 21,816$  lb

### 8 Breaking wave loads ( $F_{brkp}$ ) on seaward row of pilings:

$F_{brkp}$  on one pile =  $(1/2)C_{db}\gamma DH_b^2$

Where:  $C_{db} = 2.25$  for square piles

$\gamma = 64.0$  lb/ft<sup>3</sup> for salt water

$D = 8 \text{ in}/12 = 0.67$  ft

$H_b = 0.78d_s = (0.78)(4.6) = 3.6$  ft

So  $F_{brkp} = (1/2)(2.25)(64.0)(0.67)(3.6)^2$

$F_{brkp}$  on one pile = 625 lb

Number of piles in seaward row = 7

**$F_{brkp}$  on seaward row of piles =  $(625)(7) = 4,375$  lb**

### 9 Debris impact load ( $F_i$ ) from a 1,000-lb object on one pile:

$F_i = wV/gt$

Where:  $w = 1,000$  lb

$g = 32.2$  feet/sec<sup>2</sup>

$t$  is from Table 11.3 and is approximately 0.5 sec

So debris impact load =  $(1,000)(12.2)/(32.2)(0.5)$

**Debris impact load = 758 lb**



#### NOTE

Because the four piles under the seaward edge of the porch do not support the house, they are not included in the calculation in Step 7. Therefore, the seven piles in the seaward row referred to in Step 7 are those at the seaward edge of the house, and the piles not in the seaward row are the remaining 24 piles under the house.

Flood Load Computation Worksheet		Non-Tsunami Coastal A Zones (Solid Foundation)
Owner Name: _____ Prepared by: _____		
Address: _____ Date: _____		
Property Location: _____		
<p><b>Constants</b></p> <p><math>\gamma</math> (specific weight of water) = 62.4 lbs/ft<sup>3</sup> for fresh water and 64.0 lbs/ft<sup>3</sup> for salt water</p> <p><math>\rho</math> (mass density of fluid) = 1.94 slugs/ft<sup>3</sup> for fresh water and 1.99 slugs/ft<sup>3</sup> for salt water</p> <p><math>g</math> (gravitational constant) = 32.2 ft/sec<sup>2</sup></p> <p><b>Variables</b></p> <p><math>d_s</math> (design stillwater flood depth (ft)) =</p> <p>Vol (volume of flood water displaced (ft<sup>3</sup>)) =</p> <p><math>V</math> (velocity (fps)) =</p> <p><math>C_{db}</math> (breaking wave drag coefficient) =</p> <p><math>H_b</math> (breaking wave height (ft)) =</p> <p><math>C_p</math> (dynamic pressure coefficient) =</p> <p><math>C_d</math> (drag coefficient) =</p> <p><math>a,w</math> (width of structure (ft)) =</p> <p><math>w</math> (debris object weight (lb)) =</p> <p><math>A</math> = area of structure face (ft<sup>2</sup>) =</p>	<p><b>Summary of Loads:</b></p> <p><math>F_{sta} =</math></p> <p><math>F_{buoy} =</math></p> <p><math>F_{brkw} =</math></p> <p><math>F_{dyn} =</math></p> <p><math>F_i =</math></p> <p><math>S_{max} =</math></p>	
<b>Formula 11.3 Lateral Hydrostatic Load</b>		
$F_{sta} = (1/2)\gamma d_s^2(w)$		
<b>Formula 11.4 Vertical (Buoyancy) Hydrostatic Load</b>		
$F_{buoy} = \gamma(Vol)$		
<b>Formula 11.6 Breaking Wave Load on Vertical Walls</b>		
$F_{brkw} = (1.1C_p \gamma d_s^2 + 2.41\gamma d_s^2)w$ (if dry behind wall)		
or $F_{brkw} = (1.1C_p \gamma d_s^2 + 1.91\gamma d_s^2)w$ (if stillwater level is the same on both sides of wall)		
<b>Formula 11.7 or 11.8 Hydrodynamic Load</b>		
$F_{dyn} = \gamma d_s \{(1/2)C_d V^2/g\}(w)$ (if flow velocity $\leq 10$ fps)		
or $F_{dyn} = (1/2) C_d \rho V^2 A$ (if flow velocity $> 10$ fps)		
<b>Formula 11.9 Debris Impact Load</b>		
$F_i = wV/gt$		
<b>Formula 11.10b Local Scour</b>		
$S_{max} = d_s \{2.2(a/d_s)^{0.65} [V/(gd_s)^{0.50}]^{0.43}\}K$		

**Flood Load Computation Worksheet** Non-Tsunami V Zones and Coastal A Zones (Open Foundation)

Owner Name: \_\_\_\_\_ Prepared by: \_\_\_\_\_  
 Address: \_\_\_\_\_ Date: \_\_\_\_\_  
 Property Location: \_\_\_\_\_

**Constants**

$\gamma$  (specific weight of water) = 62.4 lbs/ft<sup>3</sup> for fresh water and 64.0 lbs/ft<sup>3</sup> for salt water  
 $\rho$  (mass density of fluid) = 1.94 slugs/ft<sup>3</sup> for fresh water and 1.99 slugs/ft<sup>3</sup> for salt water  
 $g$  (gravitational constant) = 32.2 ft/sec<sup>2</sup>

**Variables**

$d_s$  (design stillwater flood depth (ft)) =  
 $V$  (velocity (fps)) =  
 $C_{db}$  (breaking wave drag coefficient) =  
 $a, D$  (pile diameter (ft)) =  
 $H_b$  (breaking wave height (ft)) =  
 $C_p$  (dynamic pressure coefficient) =  
 $C_d$  (drag coefficient for piles) =  
 $a, w$  (width of structure (ft)) =  
 $w$  (debris object weight (lb)) =  
 $A$  = area of structure face (ft<sup>2</sup>) =

**Summary of Loads:**

$F_{brkp} =$   
 $F_{dyn} =$   
 $F_i =$   
 $S_{max} =$

**Formula 11.5 Breaking Wave Load on Vertical Piles**

$$F_{brkp} = (1/2)C_{db}\gamma D H_b^2$$

**Formula 11.7 or 11.8 Hydrodynamic Load**

$$F_{dyn} = \gamma d_s \{ (1/2) C_d V^2 / g \} (w) \text{ (if flow velocity } \leq 10 \text{ fps)}$$

or

$$F_{dyn} = (1/2) C_d \rho V^2 A \text{ (if flow velocity } > 10 \text{ fps)}$$

**Formula 11.9 Debris Impact Load**

$$F_i = wV/gt$$

**Formula 11.10a Local Scour**

$$S_{max} = 2.0a$$



## 11.7 Tsunami Loads

Tsunami loads on residential buildings may be calculated in the same fashion as other flood loads; the physical processes are the same, but the scale of the flood loads is substantially different in that the wavelengths and runup elevations of tsunamis are much greater than those of waves caused by tropical or extratropical cyclones. If the tsunami acts as a rapidly rising tide, most damage will be caused by buoyant and hydrostatic forces (see *Tsunami Engineering* [Camfield 1980]). When the tsunami forms a borelike wave, the effect is a surge of water to the shore. When this occurs, the expected flood velocities are substantially higher. Both Camfield and Dames & Moore (1980) suggest that this velocity should be  $V = 2(gd)^{0.5}$ . Figure 11-16 shows the relationship between design stillwater depth and expected velocity for tsunami and non-tsunami conditions.

**Figure 11-16**  
Tsunami velocity vs. design stillwater depth. Non-tsunami velocities are shown for comparison.

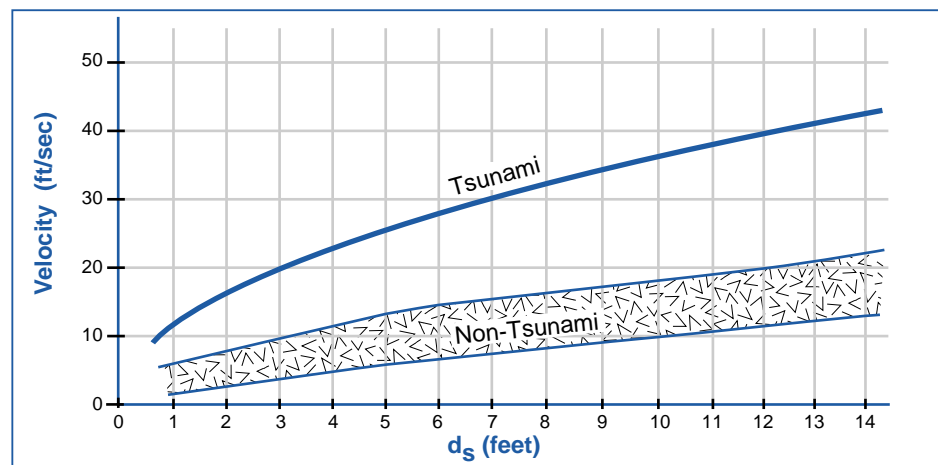

The tsunami velocities shown in Figure 11-16 are very large and if realized at the greater water depths, would cause substantial damage to all buildings in the path of the tsunami. Designers should collect as much data as possible about expected tsunami depths to more accurately calculate tsunami flood forces.



### NOTE

It is not the intent of this manual to replace or change provisions of ASCE 7-98. The determination of important wind load criteria is highlighted in this manual. For complete coverage of this subject, the designer should consult ASCE 7-98.

## 11.8 Wind Loads

The ASCE standard ASCE 7-98, *Minimum Design Loads for Buildings and Other Structures* (ASCE 1998b), was considered the state-of-the-art in wind load design technology and was a consensus standard at the time this manual went to print. It comprehensively covers the effects of wind pressures on a variety of building types and building elements. The design for wind loads is essentially the same whether the winds are due to hurricanes, thunderstorms, or tornadoes. Two additional references are recommended as design aides: the *AIA Wind Design Primer* available from the American Institute of Architects (AIA 1994) and the *Guide to the Use of the Wind Load Provisions* (Mehta and Marshall 1995) available from ASCE.

Designers may notice several differences between the wind load provisions of ASCE 7-98 and those of familiar model building codes. As a result, in some circumstances, design wind loads determined with ASCE 7-98 may be higher or lower than those from local or model codes.

It is important to calculate wind pressures for both the structural frame (called the Main Wind Force Resisting System, or MWFRS, in ASCE 7-98) and for building components and cladding. Components and cladding include elements such as roof sheathing, roof coverings, exterior siding, windows, doors, soffits, facia, and chimneys. Investigations of wind-damaged buildings after disasters have shown that many building failures start because a component or piece of cladding is blown off the building, allowing wind and rain to enter the building. The uncontrolled entry of wind into the building creates internal pressure that, in conjunction with negative external pressures, can “blow the building apart.”

The most important factors that affect wind load design are as follows:

- ASCE uses the 3-sec peak gust wind speed as the criterion for velocity averaging times instead of the fastest-mile speed used in most codes that were available prior to 2000.
- Topographic effects (hills and escarpments) create a wind speedup effect.
- The wind speed maps in ASCE 7-98, IBC2000 (ICC 2000a), and the IRC (ICC 2000b) are based on an approximately 50-year – 100-year wind. Increasing the recurrence interval of the design wind to provide protection from a more infrequent event is accomplished in ASCE 7-98 by increasing the building importance factor (I).
- Building height and shape affect wind loads.
- Terrain conditions affect the exposure of the building to wind.

The following short discussion of wind/building interaction theory helps explain how wind flows over and around buildings. Methods for calculating wind pressure are presented after this discussion.

The effects of wind on buildings can be summarized as follows (see Figure 11-17):

- Windward walls and steep-sloped roofs are acted on by inward-acting, or positive, pressures.
- Leeward walls and steep- and low-sloped roofs are acted on by outward-acting, or negative, pressures.
- Air flow separates at sharp edges and at points where the building geometry changes.



## NOTE

Using ASCE 7-98 effectively requires some practice in the application of many of its provisions. The following particularly require judgment in the use of the specific design guidelines, coefficients, and requirements:

- determining exposure categories
- deciding whether to use Figure 6-3 or 6-4 for external pressure coefficients
- interpolating graphs for components and cladding external pressure coefficients
- determining the effective wind area for components and cladding pressure coefficients



## NOTE

Basic wind speeds given by ASCE 7-98, shown in Figure 7-23, correspond to (1) a wind with a recurrence interval between 50 and 100 years in hurricane-prone regions (Atlantic and Gulf of Mexico coasts with a basic wind speed greater than 90 mph, and Hawaii, Puerto Rico, Guam, the U.S. Virgin Islands, and American Samoa), and (2) a recurrence interval of 50 years in non-hurricane-prone areas.

- Localized suction, or negative, pressures at eaves, ridges, and the corners of roofs and walls are caused by turbulence and flow separation. These pressures affect loads on components and cladding.

**Figure 11-17**  
Effect of wind on an enclosed building and a building with an opening.

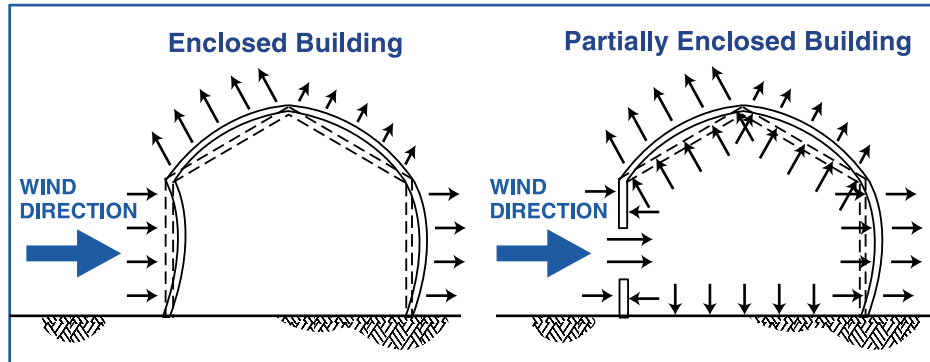

The phenomena of localized high pressures occurring at points where the building geometry changes is accounted for by the various shape coefficients in the equations for both the MWFRS and components and cladding. Internal pressures must be included in the determination of wind pressures and are additive to (or subtractive from) the external pressures. Openings and the natural porosity of the building components contribute to internal pressure.

It is important to understand the following about openings and the protection of openings:

- The magnitude of internal pressures depends on whether the building is “enclosed,” “partially enclosed,” or “open” as defined by ASCE 7-98.
- In hurricane-prone regions as defined in ASCE 7-98, in order for a building to be considered “enclosed” for design purposes, glazing must either be impact-resistant or protected with shutters or other devices that are impact-resistant. It should be noted that this requirement also applies to glazing in doors.
- In hurricane-prone regions as defined by ASCE 7-98, glazing that is not impact-resistant or is not protected by shutters or other devices that are impact-resistant is permitted, provided the building is considered to be a “partially enclosed building.” This will require that the building be designed for higher internal pressures than required for enclosed buildings. Because of the high potential for glass breakage in hurricane-prone regions, which will result in damage from wind and water intrusion, this approach is not recommended.
- The test standard referenced in Section 12.7.4.2, in Chapter 12 of this manual, should be used in determining whether glazing or protection for glazing will withstand the impact of windborne debris.



### CROSS-REFERENCE

Section 12.7.4.2, in Chapter 12, discusses test criteria for determining the resistance of glazing and glazing protection to the impact of windborne missiles.

Wind forces must be evaluated not only for inward- and outward-acting pressures, but also pressure normal to and parallel to the main roof ridge. Ultimately, the wind load case that results in the greatest pressures, either positive or negative, should be used as the basis for wind-resistant design. This procedure requires that the designer determine how various combinations of building characteristics such as size, shape, and height will affect the flow of the wind over and around the building and the resulting pressures on the building. Consequently, for a designer who is trying to minimize wind pressures by altering these characteristics, wind design will be a trial-and-error process.

### 11.8.1 Main Wind Force Resisting System (MWFRS)

The MWFRS consists of the foundation, floor supports (e.g., joists, beams), columns, roof rafters or trusses, and bracing, walls, and diaphragms that assist in transferring loads. ASCE 7-98 (ASCE 1998b) defines the MWFRS as "... an assemblage of structural elements assigned to provide support and stability for the overall structure." The commentary in ASCE 7-98 suggests that the components of roof trusses be analyzed for loads based on components and cladding coefficients and that the truss, as a single element, be analyzed for loads as part of the MWFRS. The designer needs to consider appropriate loadings based on the type of building component used in the MWFRS.

The following procedure is suggested as a means of determining the net wind pressures that must be considered. It will help the designer use ASCE 7-98 effectively.



#### NOTE

ASCE 7-98, Chapter 6, presents a simple procedure for determining velocity pressures for buildings defined as regular shaped that have a simple diaphragm, a mean roof height less than or equal to 30 feet, and a roof slope less than 10 degrees (a pitch of approximately 2:12). When these conditions are met, the ASCE 7-98 procedure may be used instead of the formulas that appear in the Wind Load Example Problem on pages 11-45 through 11-47.

#### Wind Load Determination Procedure

- STEP 1** Determine the wind speed from the map shown in Figure 11-18, on pages 11-38 and 11-39. (More detailed maps for Atlantic and Gulf of Mexico coasts are included in Figures 6.1a through 6.1c of ASCE 7-98.)
- STEP 2** Define the building as either open, partially enclosed, or enclosed.
- STEP 3** Determine the Exposure Category: A, B, C, or D (see ASCE 7-98).
- STEP 4** Determine the Importance Factor  $I$  and the topographical influence factor  $K_{zt}$ .
- STEP 5** Determine the velocity pressure at the appropriate mean roof height.
- STEP 6** Select appropriate internal and external pressure coefficients.
- STEP 7** Determine the design pressures (all pressures should be net pressure; use + to indicate inward-acting pressure and – to indicate outward-acting pressure).
- STEP 8** Apply the design pressure to the appropriate tributary area for the element or assembly under consideration.



**Figure 11-18**  
Wind speed map (ASCE 1998b)

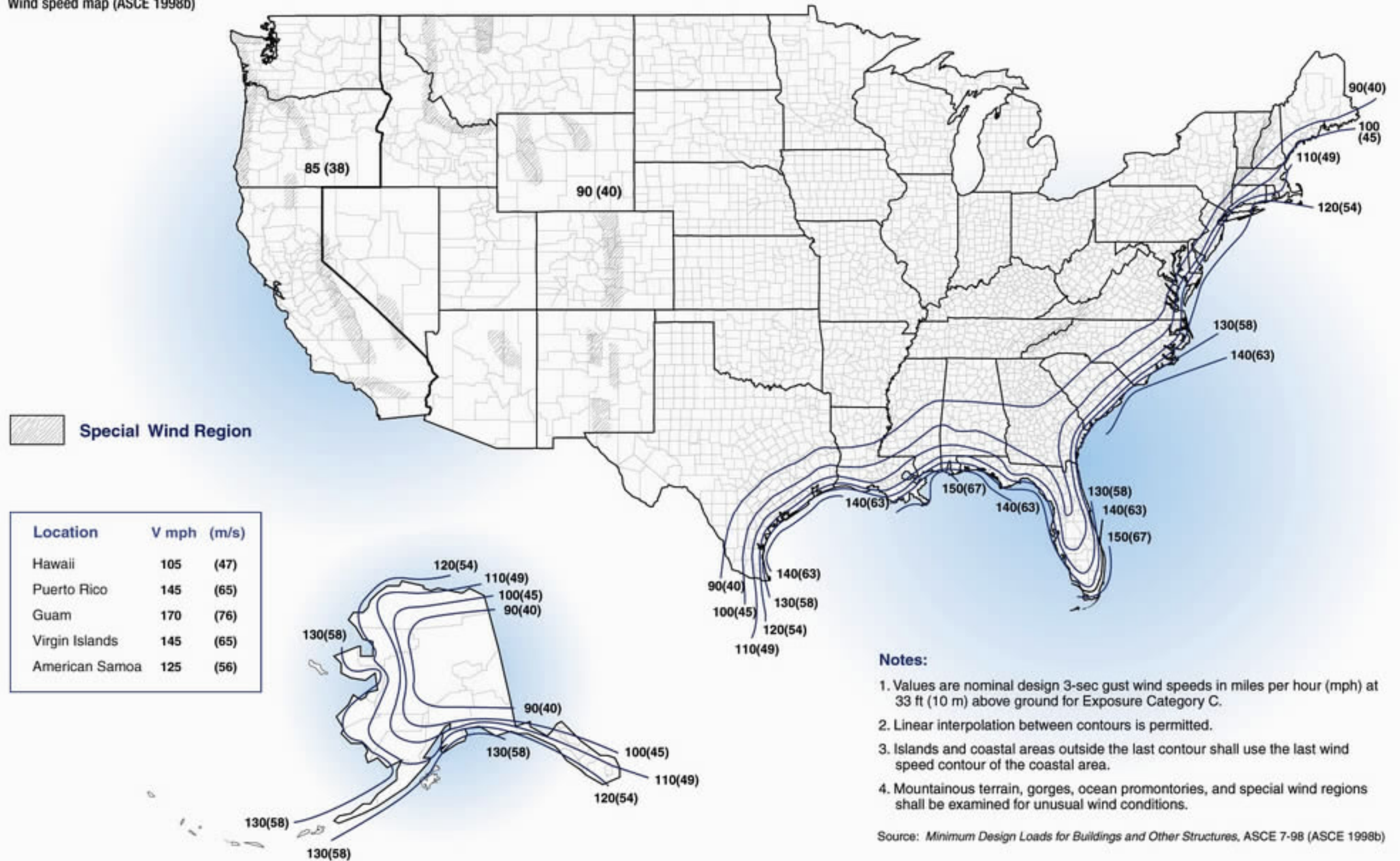

A complete analysis of the MWFRS requires that the building be exposed to wind coming from each of four principal directions. For a typical building configuration, this means that in two cases the wind direction will be perpendicular to the roof ridge, and in the other two cases it will be parallel to the ridge. A complete analysis includes a determination of the following:

- windward and leeward wall pressures
- side wall pressures
- windward and leeward roof pressures
- pressures on roof overhangs and porches

Figure 11-19 shows the distribution of these pressures on the building that appears in the Wind Load Example Problem on pages 11-45 through 11-47.

**Figure 11-19**  
Wind pressures on the MWFRS on a cross section of the case study building.



### NOTE

The windward side of the roof may receive positive (inward) pressure depending on the roof slope.

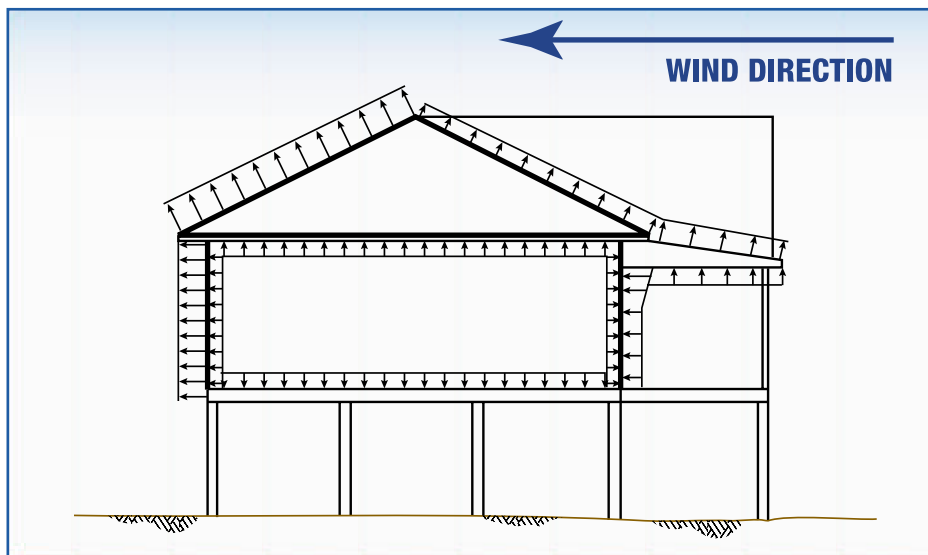

## 11.8.2 Components and Cladding

ASCE 7-98 defines components and cladding as “... elements of the building envelope that do not qualify as part of the MWFRS.” These elements include roof sheathing, roof coverings, exterior siding, windows, doors, soffits, fascia, and chimneys. **The design and installation of the roof sheathing attachment may be the most critical consideration**, because the attachment point is where the uplift load path begins (see Chapter 12 for more information on load paths).

Component and cladding pressures are determined for various “zones” of the building. ASCE 7-98 includes illustrations of those zones for both roofs and walls. Illustrations for gable, monoslope, and hip roof shapes are presented. The pressure coefficients vary according to roof pitch (from 0 degrees to 45 degrees) and effective wind area (defined in ASCE 7-98). Pressures at building corners are based on the effective wind area at the corner expressed as a percentage of the building length or width or as a minimum dimension.

Figure 11-20 shows the locations and relative magnitudes of localized pressures on wall and roof surfaces. These pressures are shown in Figure 6-5 of ASCE 7-98.

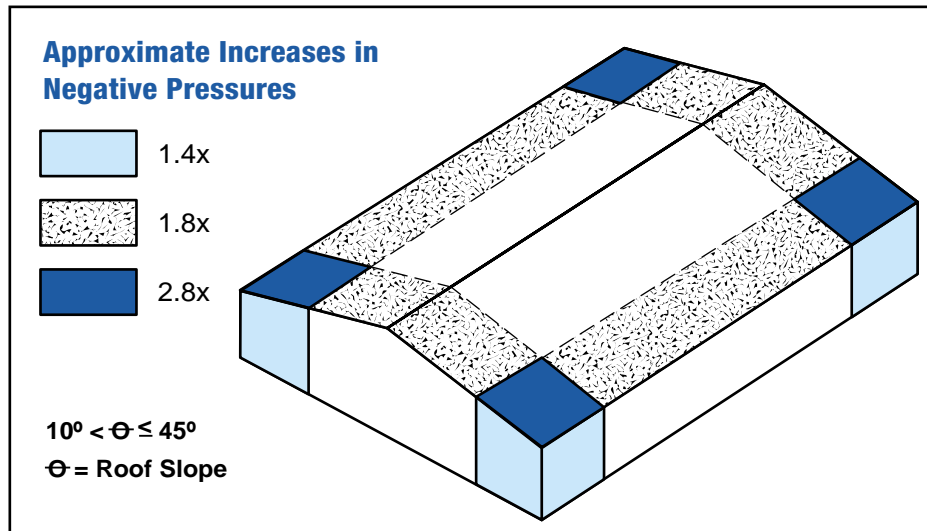

**Figure 11-20**  
Wind pressures on the  
MWFRS.

It is important to note that the effective wind area for cladding fasteners is the area of the cladding attached by one fastener, so the area is very small. Pressure coefficients are highest for small areas as shown by the figures in ASCE 7-98.

The determination of wind pressures on components and cladding is illustrated in the Wind Load Example Problem on pages 11-45 through 11-47.

Residential buildings, particularly wood-frame and steel-frame buildings, are constructed with many small pieces, all of which are joined with some type of fastener such as a nail, screw, or mechanical connector. A failure of any one fastener increases the load on adjacent fasteners. The cyclic nature of wind forces can cause fatigue failure. For the designer, this failure mode suggests that design loads should be stipulated for the following:

- exterior siding, including the expected shear and withdrawal loads on fasteners
- roof sheathing
- wall sheathing
- roof coverings
- soffits and overhangs
- windows and window frames
- doors and door frames, including garage doors
- any attachments to the building (e.g., antennas, chimneys)

Figure 11-21 shows some of the many pieces that must be connected in a small section of a wood-frame residential building. A complete design would include load requirements for all of the connections necessary for the construction of this and all other wall sections in the building.

**Figure 11-21**  
Typical building connections.

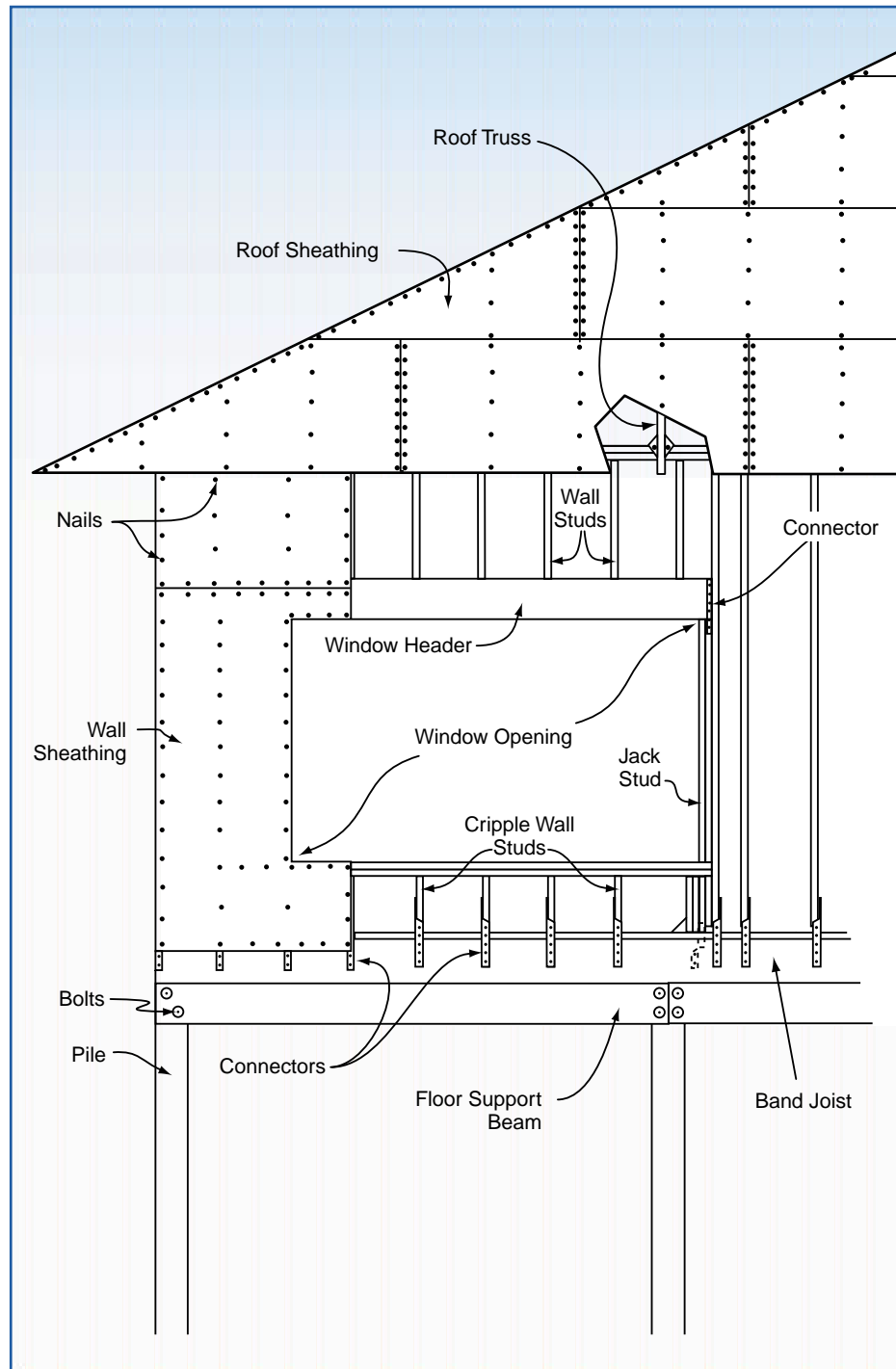





## Example

## Wind Load Example Problem

## Given:

1. Wind direction is perpendicular to the roof ridge (see Figure 11-22).
  2. Wind speed is 120 mph (3-sec peak gust).
  3. DFE = 14 feet NGVD
  4. Building is one-story; wall height = 10 feet.
  5. Main roof pitch is 6:12.
  6. Exposure is Category C (refer to ASCE 7-98).
  7. The following values are determined from ASCE 7-98:
    - $K_d = 0.85$
    - $K_z = 0.93$  (from interpolation of Table 6-5 in ASCE 7-98)
    - $K_{zt} = 1.0$
    - $G = 0.878$  (calculated using Equation 6-2 in ASCE 7-98)
- Mean roof height ( $h$ ) = 24.0 feet above ground

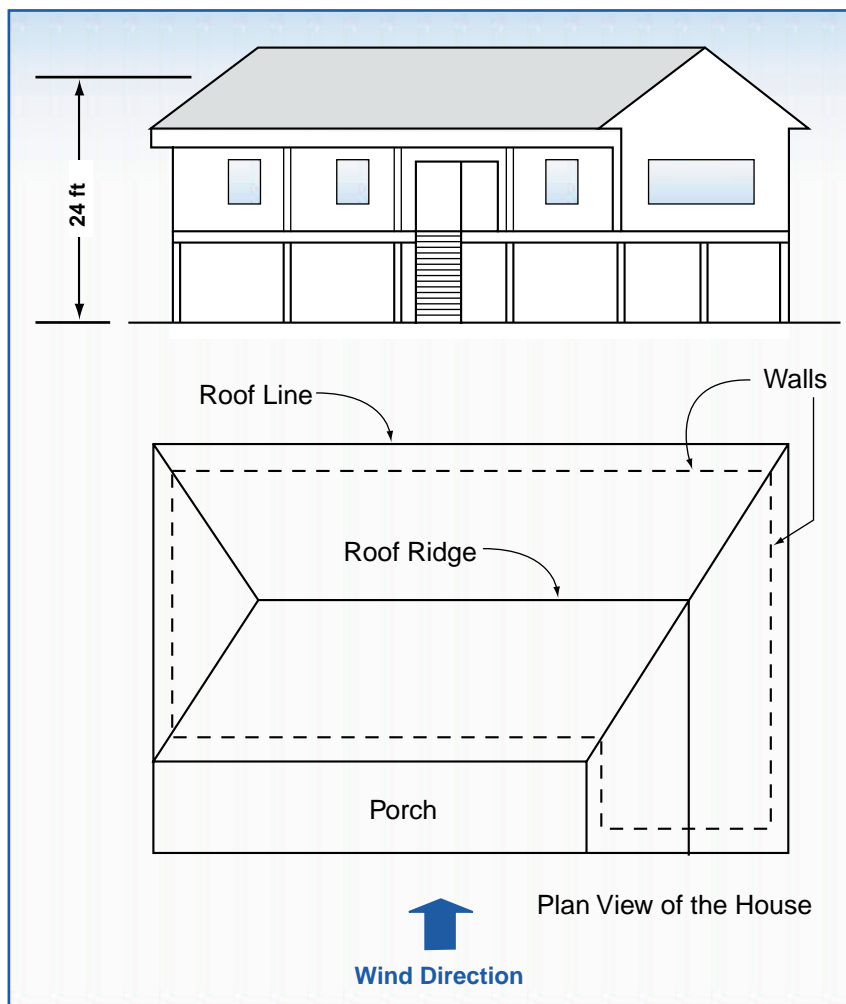

**Figure 11-22** Building elevation and plan view of roof.

8. The building is "enclosed."
9. The building is in a V zone within 1,600 feet of the shoreline.

## Find:

1. design pressures for the MWFRS (including the porch roof):
  - a) for wind perpendicular to the main roof ridge (east-west)
  - b) for wind parallel to the main roof ridge (north-south)
2. design pressures for the components and cladding for an assumed effective area of 20 ft<sup>2</sup>

**Note:** Different elements may have different effective wind areas (e.g., large windows vs. siding fasteners). Calculations should be based on appropriate effective wind areas.



# Wind Load Example Problem (continued)

## 1 Wind pressure for the MWFRS:

$$p = q_z(GC_p) - q_h(GC_{pi}) \text{ [See ASCE 7-98 for a description of these terms.]}$$

The wind pressure zones from Figure 6-3 in ASCE 7-98 are shown in Figure 11-23. The computed pressures are listed in Table 11.7

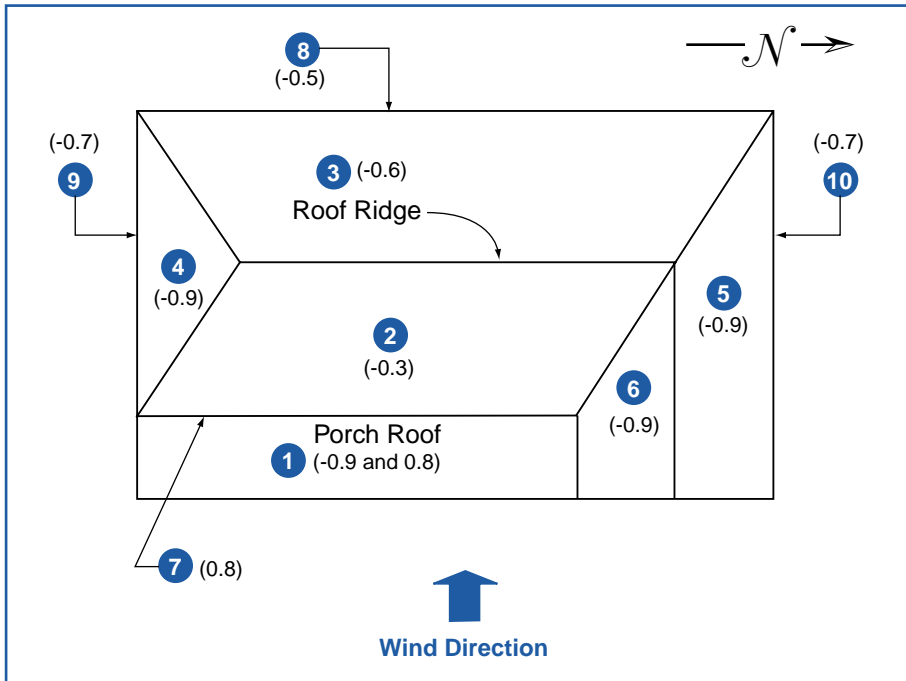

**Figure 11-23**  
Wind pressure zones for MWFRS. The external pressure coefficients ( $C_p$ ) for the 10 zones indicated are provided here for the case of wind direction from the east.

Wind Pressure Zone (see Figure 11-23)	Wind Direction			
	East	West	North	South
1 Porch overhang	<b>-45.45</b>	-12.30	-22.14	<b>-45.45</b>
2 Front roof	-12.63	-20.01	<b>-27.39</b>	<b>-27.39</b>
3 Rear roof	-20.01	-12.63	<b>-27.39</b>	<b>-27.39</b>
4 Left hip roof	<b>-27.39</b>	<b>-27.39</b>	-20.01	4.60
5 Right hip roof	<b>-27.39</b>	<b>-27.39</b>	4.60	-20.01
6 Left front gable	<b>-27.39</b>	<b>-27.39</b>	-20.01	4.60
7 Front wall	14.44	-17.55	<b>-22.47</b>	<b>-22.47</b>
8 Rear wall	-17.55	14.44	<b>-22.47</b>	<b>-22.47</b>
9 Left side wall	<b>-22.47</b>	<b>-22.47</b>	-15.09	14.44
10 Right side wall	<b>-22.47</b>	<b>-22.47</b>	14.44	-15.09

**Table 11.7**  
Summary of Wind Pressures ( $p$ ) for MWFRS

**Notes:**

- (1) Locations on the building are taken from the east, facing the building.
- (2) All pressures are in lbs/ft<sup>2</sup> and have been rounded to the nearest two decimal places.
- (3) + pressures act toward the building.
- (4) - pressures act away from the building.
- (5) Highest pressures are indicated in bold.

# Example Wind Load Example Problem (continued)

## 2 Wind pressures for components and cladding:

$$p = q_h [(GC_p) - (GC_{pi})C]$$

The wind pressure zones for components and cladding are shown in Figure 11-24.

The computed pressures are listed in Table 11.8.

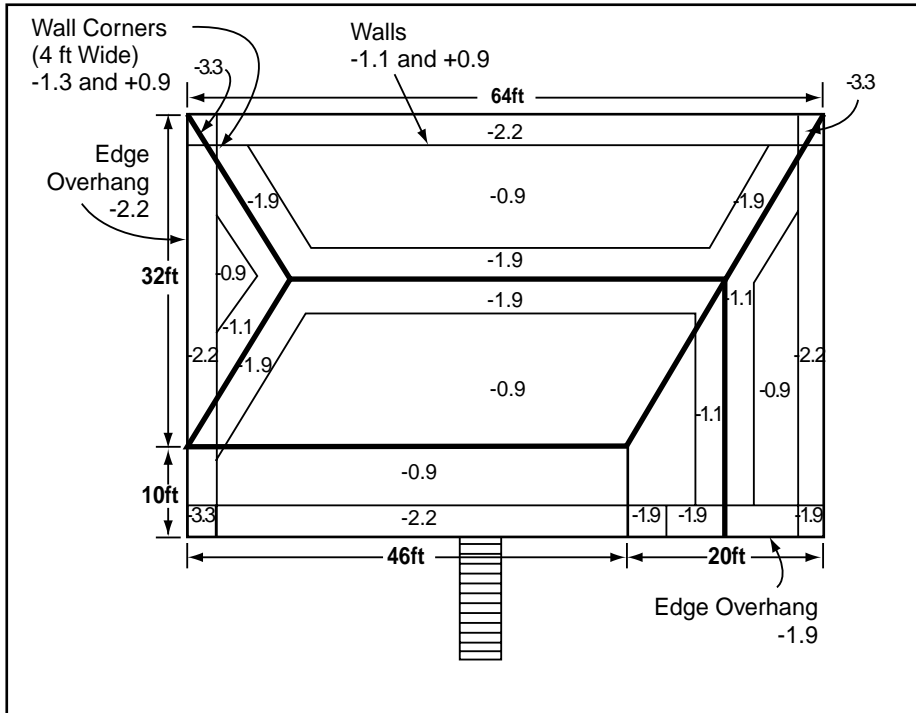

**Figure 11-24**  
Wind pressure zones for components and cladding; most severe negative pressure coefficients shown.

Wind Pressure Zone (see Figure 11-24)	GC <sub>p</sub> Coefficients	Wind Pressure (lb/ft <sup>2</sup> )
Corners of hip roof and front porch	-3.3	-119.48
Interior of hip and porch roofs	-0.9	-31.47
Steep-sloped hip and gable roofs	-0.9	-31.47
Hip roof overhang edge	-2.2	-87.42
Steep hip and gable and edges	-1.9	-78.68
Wall corner	-1.3	-43.13
Main wall area	-1.1	-37.3
Porch roof edge	-2.2	-69.36

**Table 11.8**  
Summary of Wind Pressures for Components and Cladding

**Notes:**

1. All pressures are in lbs/ft<sup>2</sup> and have been rounded to the nearest two decimal places.
2. + pressures act in toward the building.
3. - pressures act away from the building.
4. Effective area of 20 ft<sup>2</sup> is assumed.

## 11.9 Tornado Loads

Tornadoes are frequently spawned by hurricanes and other severe weather systems, but tornado wind speeds can be much greater than hurricane wind speeds (see Commentary, Section C6.5.4.3 of ASCE 7-98). ASCE 7-98 specifically excludes tornadoes from consideration in the basic wind speed distributions. Designing an entire building to resist tornado-force winds of F2 or greater on the Fujita Scale is usually beyond the realm of practicality and cost-effectiveness. A more practical approach is to consider constructing an interior room or space that is specifically “hardened” to resist not only tornado-force winds, but also the impact of windborne missiles.

FEMA Publication No. 320, *Taking Shelter From the Storm: Building a Safe Room in Your House* (FEMA 1998), provides general information about tornado and hurricane hazards and includes risk assessment aids. It also includes detailed construction plans for several types of shelters that are designed to provide protection from both extremely high winds and windborne missiles. The research and materials testing work performed for this project were conducted by the Wind Engineering Research Center at Texas Tech University.

## 11.10 Seismic Loads

The 1997 *NEHRP Recommended Provisions for Seismic Regulations for New Buildings and Other Structures* (FEMA 1997), published by the Building Seismic Safety Council for FEMA, is considered the state-of-the-art seismic design standard. The 1997 NEHRP (National Earthquake Hazard Reduction Program) Provisions served as the basis for the seismic provisions in the IBC 2000 (ICC 2000a) and the IRC 2000 (ICC 2000b), and are similar in many respects to the seismic provisions of the 1997 *Uniform Building Code*. The seismic provisions in the 1993, 1996, and 1999 editions of *The BOCA National Building Code* and the 1994 and 1997 editions of the *Standard Building Code* are based on the 1991 NEHRP Provisions.

This manual uses the seismic provisions of the IBC 2000 to illustrate the seismic design procedure. Because the procedure is complex and is covered thoroughly in the two documents referred to above, as well as in the other model building codes, this manual will present only the basic steps of the procedure. It is important to understand the basic principles of seismic design because some are in conflict with the design requirements for other natural hazards. Finding ways to resolve these design conflicts is an important task for the designer.



### NOTE

The IBC 2000 includes provisions that exempt detached one- and two-family dwellings located in areas where  $S_{DS}$  is  $< 0.4$  from the seismic design requirements of the IBC. Designers should consult local officials to clarify specific design requirements.

Specific seismic design requirements and calculation methods are presented later in this section, but first, a short discussion of seismic theory will help explain the effects of seismic ground shaking motion on buildings. These effects can be summarized as follows:

- Ground motion during a seismic event is both lateral and vertical, thus the motion of the affected building is also both lateral and vertical.
- To simplify design, the effect of dynamic seismic ground motion accelerations can be considered an equivalent static lateral force applied to the building. The magnitude of dynamic motion, and therefore the magnitude of the equivalent static design force, depends on the site location, the site soil properties, and the building characteristics.
- The ground shaking motion immediately displaces the foundation of the building more than the building mass above the foundation. As a result, the difference between the immediate displacement of the foundation and that of the rest of the building causes deformation and stress in the supporting elements of the building. This is an important consideration for buildings elevated on pile foundations. Because of the height of such buildings and the slenderness of the foundation members, the seismic demands on the foundation of an elevated pile-supported building can be greater than those on the foundation of a ground-level building.
- Irregularities in the shape, mass, and structural stiffness of a building will cause non-uniform displacements when the building mass moves.
- Acceptable building performance for life safety during a major seismic event is defined as non-collapse; some structural and non-structural building damage is acceptable if it does not prevent egress from the building.
- Actual seismic forces can exceed the code design forces; therefore, the ductility of building elements and connections is important. Ductility is the ability to sustain large deformations without losing strength.

Figures 11-25 through 11-27 show how ground motion resulting from a seismic event causes buildings to move and leads to failures.

The seismic shaking creates shear and overturning forces and deformation in the walls between the floor and roof line (see Figure 11-25). The entire load path from the roof through the walls and into the foundation must have the capacity to withstand these forces. All of the loaded elements must be able to withstand the force and deformation without failing.

**Figure 11-25**  
Shear and overturning forces.

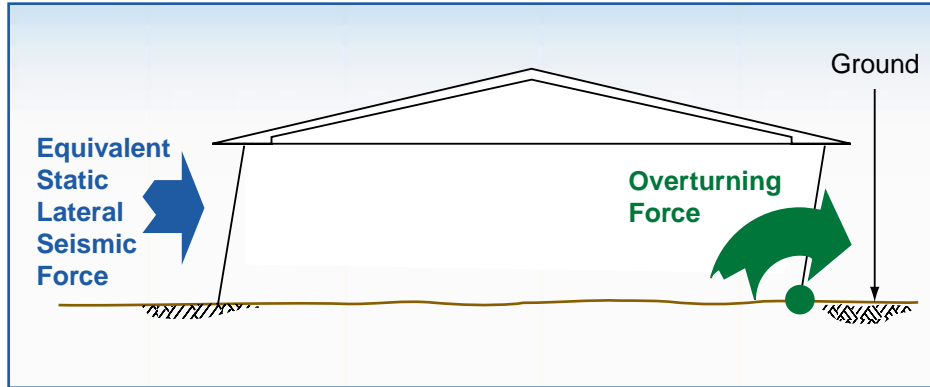

Once the structural frame becomes out of plumb, vertical gravity force can deform it further (see Figure 11-26). This is known as the P-delta effect.

**Figure 11-26**  
Gravity further deforms the out-of-plumb frame of the building.

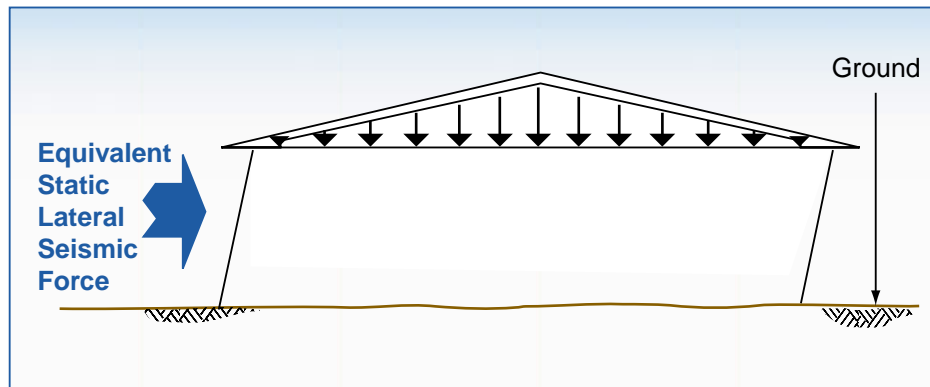

The lateral force on a cantilevered pile-supported building causes the piles to bear against the upper soil in the direction opposite the force and against the lower soil in the direction of the force (see Figure 11-27).

**Figure 11-27**  
Effect of seismic forces on supporting piles.

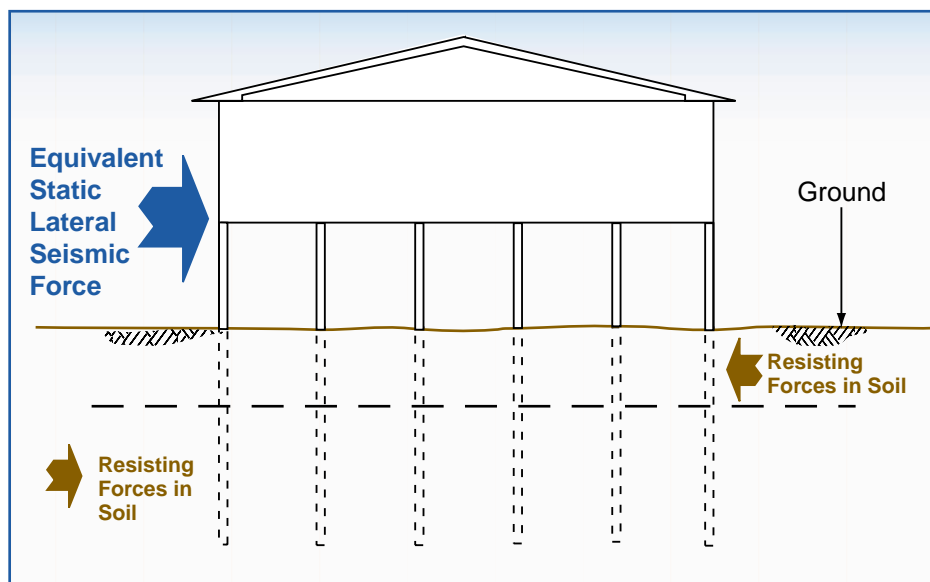

The following is a suggested seismic design procedure in accordance with the Simplified Analysis Procedure for the Seismic Design of Buildings in Chapter 16 of the IBC. The suggested procedure is similar to the wind design procedure in that it involves an evaluation of forces that act in more than one dimension.

### Seismic Load Determination Procedure

- STEP 1** Determine the site acceleration values from the Maximum Considered Earthquake Ground Motion maps in Chapter 16 of the IBC.
- STEP 2** Determine the Site Class, based on site soil characteristics.
- STEP 3** Select an appropriate seismic-force-resisting structural system.
- STEP 4** Estimate the dead weight of the building by level.
- STEP 5** Determine the additional loads (e.g., snow, storage, equipment) that must be added to the weight of the building in the calculation of the Effective Seismic Weight of the building.
- STEP 6** Determine the total seismic force or base shear.
- STEP 7** Determine the seismic force at each building level.
- STEP 8** Distribute the seismic force into the foundation.

These steps are described in somewhat more detail below. The complete execution of the steps would require the use of the IBC.

#### STEP 1

Using the Maximum Considered Earthquake Ground Motion maps in the Earthquake Loads section of Chapter 16 of the IBC, find the short-period maximum considered earthquake spectral response seismic acceleration for the building location.

#### STEP 2

The Site Class, in accordance with the Site Class Definitions table in Chapter 16 of the IBC, can be determined with a geotechnical analysis that measures the site soil shear wave velocity, penetration resistance, and/or unconfined shear strength. The IBC includes guidelines for assuming a Site Class if a geotechnical analysis is not performed.

**STEP 3**

Using the preliminary plans from the building designer, select the structural seismic-force-resisting system or systems in accordance with the Design Coefficients and Factors for Basic Seismic-Force-Resisting Systems table in the IBC. This information is necessary for determining the Response Modification Coefficient  $R$  in Step 6.

**STEP 4**

The IBC and many building construction texts provide guidance for determining the dead weight of the building. The dead weight must then be distributed to the appropriate levels of the building (e.g., roof, each story)

**STEP 5**

The IBC states to what degree other loads (e.g., snow, storage, equipment) must be added to the dead weight of the building in the calculation of the Effective Seismic Weight of the building.

**STEP 7**

The determination of the total seismic force, or base shear, is described fully in the IBC and the NEHRP Provisions. The force must be determined for each plan direction. The Simplified Analysis Procedure from the IBC can often be used on smaller coastal buildings such as the residential buildings for which this manual is intended. Larger and more complex buildings will require a more complex analysis procedure.

The analysis procedures require that the Response Modification Coefficient  $R$  be determined, based on the structural system assumed in Step 3. Total seismic base shear is then computed with Formula 11.11.



Seismic Base Shear  
by the Simplified  
Analysis Procedure

**Formula 11.11 Seismic Base Shear by  
the Simplified Analysis Procedure**

$$V = 1.2S_{DS}W/R$$

where:  $S_{DS}$  = Design Spectral Response Acceleration, calculated using the short-period maximum considered earthquake spectral response seismic acceleration from Step 1 and the Site Class from Step 2

$W$  = Effective Seismic Weight of the building in lb from Steps 4 and 5.

$R$  = Response Modification Coefficient of structural system



All base shear methods require that the Response Modification Coefficient  $R$  be determined. The Response Modification Coefficient is an indicator of structural system seismic behavior. The larger the coefficient, the greater the system ductility and damping. The Design Coefficients and Factors for Basic Seismic-Force-Resisting Systems table in the IBC lists coefficients by structural system, but the descriptions of building frame types in the table do not adequately cover typical coastal pile-supported structural systems. The following additional structural systems with recommended  $R$  values have been considered by the Seismology Committee of the Structural Engineers Association of California and the appropriate NEHRP committee.

- Cantilevered piles supporting a light-frame shear-panel building of one to three stories. The piles are sufficiently embedded in the soil to be moment-resisting at the base. **Recommended  $R = 2.2$**
- Diagonal-braced piles supporting a light-frame shear-panel building of one to three stories. The diagonal braces are tension-only braces, and the piles are sufficiently embedded in the soil to be moment-resisting at the base. **Recommended  $R = 2.8$**
- Pole construction in which the pile/pole extends vertically into a light-frame shear-panel building of one to three stories. The drift restraint provided by the shear walls serves to fix the rotation at the top of the piles/poles. The piles are sufficiently embedded in the soil to be moment-resisting at the base. **Recommended  $R = 4.5$**
- Pole construction in which the pile/pole extends vertically into a light-frame shear-panel building of one to three stories. The drift restraint provided by the shear walls serves to fix the rotation at the top of the piles/poles. The depth of embedment is not sufficient to provide moment-resistance at the base. **Recommended  $R = 2.8$**
- Knee-braced piles supporting a light-frame shear-panel building of one to three stories. The piles are sufficiently embedded in the soil to be moment-resisting at the base. The heavy timber knee braces need not carry gravity loads. **Recommended  $R = 4.5$**

A typical coastal building can have one structural seismic-force-resisting system in the elevated foundation and a different structural seismic-force-resisting system for the living spaces. The IBC allows the forces to each system to be calculated separately by the appropriate  $R$  value, as long as the superstructure  $R$  value is equal to or greater than the foundation  $R$  value.

### STEP 7

Determine the lateral force at each building level. The simplified method presented below (from the IBC) may be used for smaller coastal buildings. Larger buildings, as defined in the IBC, require a more complex analysis.

The distribution of the total horizontal force (shear) into each story of the building is determined by Formula 11.12.



**Formula 11.12**  
**Vertical Distribution of Seismic Forces**

$$F_x = 1.2S_{DS}w_x/R$$

where: **S<sub>DS</sub>** = (See Formula 11.11)  
**F<sub>x</sub>** = force at level x  
**w<sub>x</sub>** = portion of the effective seismic weight in lb at level x  
**R** = Response Modification Coefficient for structural system

One of the primary considerations for seismic design in coastal buildings is the structural configuration seismic engineers call an “inverted pendulum.” This configuration occurs in elevated pile-supported buildings, where almost all of the weight is at the top of the piles; therefore, almost all of the horizontal shear occurs at the top of the piles. This configuration creates a large overturning moment (force times moment arm or distance above the base) in the overall pile foundation system. It also creates large bending forces and deflection in the individual cantilevered piles, creating a “soft story” effect. Low R values are typically assigned to inverted pendulum structural systems. The problem of designing for this configuration is discussed further in Chapter 12 of this manual.

**STEP 8**

The principles of seismic load determination and wind load determination are similar, but seismic forces rely on building ductility and damping. Although the design wind force may be larger than the design seismic force and thus may govern the lateral force design, seismic design requirements for ductility must still be met.

The calculated seismic or wind force at each story must be distributed into the building frame. The horizontal forces and related overturning moments will be taken into the foundation through a load path of horizontal floor and roof diaphragms, shear walls, bracing, shear connections, and tiedowns.

The total shear force distributed to the bottom floor diaphragm is usually transferred through shear walls. This shear force can be distributed across the floor diaphragm into the overall pile foundation. The shear wall overturning moments must be taken into the floor framing and piles directly below the shear walls. See the Seismic Load Example Problem (on pages 11-55 and 11-56) and Chapter 12 for more information.



# Seismic Load Example Problem

**Given:**

1.  $S_{MS}$  for the site is  $F_a S_s$ , which is determined to be  $(1.2)(0.50) = 0.6$ .

2. The longitudinal shear walls are the two exterior side walls and one interior wall as shown in Figure 11-28. Dead load for the building is as follows:

Roof and ceiling – 10 lb/ft<sup>2</sup> (roof overhang considered)

Exterior walls – 10 lb/ft<sup>2</sup>

Interior Walls – 8 lb/ft<sup>2</sup>

Floor – 10 lb/ft<sup>2</sup>

Piles – 409 lb each

3. No live load is added.

**Find:**

(by IBC Simplified Analysis Procedure):

1. The maximum shear force in the 28-foot side shear wall.
2. The shear force to the pile foundation.

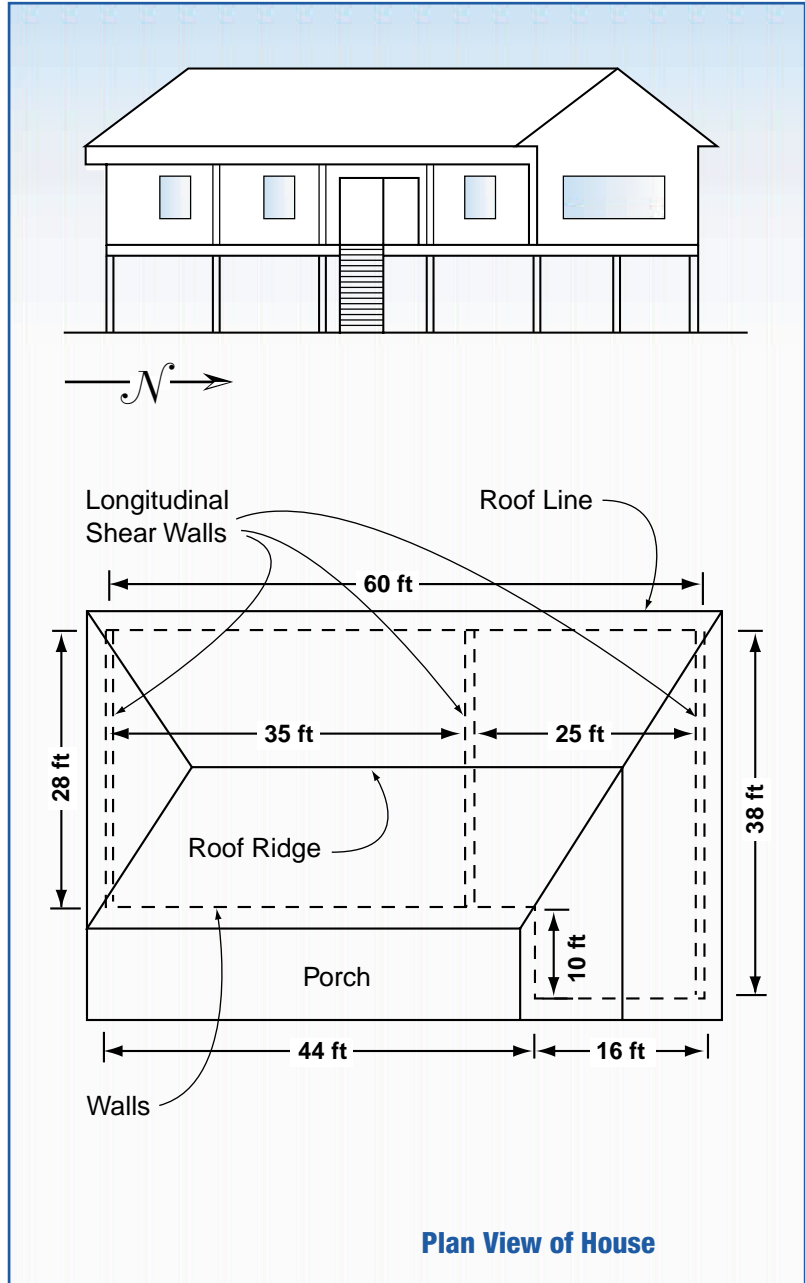

**Figure 11-28** Building elevation and plan view of roof showing longitudinal shearwalls. Dimensions are wall-to-wall and do not include 2-foot roof overhang.



## Seismic Load Example Problem (continued)

### 1 Maximum shear force in the 28-foot side shear wall:

Calculate dead weight:

$$\text{Roof, ceiling, top 1/2 of interior partitions} = (10 \text{ lb/ft}^2)(2,248 \text{ ft}^2) + 1/2 (8 \text{ lb/ft}^2)(2,000 \text{ ft}^2) \\ = 30,480 \text{ lb}$$

$$\text{Exterior walls} = (10 \text{ lb/ft}^2)(2,088 \text{ ft}^2) = 20,880 \text{ lb}$$

$$\text{Top 1/2 of piles, floor framing, floor, bottom 1/2 of interior partitions} = 1/2 (409 \text{ lb/pile}) \\ (31 \text{ piles}) + (10 \text{ lb/ft}^2)(1,840 \text{ ft}^2) + 1/2 (8 \text{ lb/ft}^2)(2,000 \text{ ft}^2) = 32,740 \text{ lb}$$

$$\text{Total dead weight (Effective Seismic Weight)} = 84,100 \text{ lb}$$

$$S_{DS} = 2/3 S_{MS} = (2/3)(0.6) = 0.402, \text{ as a percent of the acceleration of gravity}$$

R = 6.5 for light-frame walls with plywood

Force in shear walls is from roof-level weight. This is the weight tributary to the roof level plus 1/2 of the exterior wall weight.

$$F_{\text{roof}} = 1.2 S_{DS} W_{\text{roof}} / R = [(1.2)(0.402)(30,480 + (20,880/2))]/6.5$$

$$F_{\text{roof}} = 3,037 \text{ lb}$$

The 28-foot side shear wall has two 10-foot windows, so  $l_{\text{wall}} = 28 \text{ feet} - (2 \times 10 \text{ feet}) = 8 \text{ feet}$

By tributary (simple horizontal beam) distribution among the three walls:

$$F_{\text{28-foot wall}} = 3,037 \text{ lb} \times 17.5 \text{ feet} / 60 \text{ feet} = 886 \text{ lb}$$

So maximum shear in 28-foot wall, at pier panels beside windows = 886 lb/8 feet

$$\text{Maximum shear force} = 111 \text{ lb/ft}$$

### 2 Shear force to the pile foundation:

From Step 6 on page 11-52 take R = 2.2 for cantilevered piles. For vertically mixed seismic-force-resisting systems, the draft IBC allows a lower R to be used below a higher R value.

$$\text{Total dead weight (Effective Seismic Weight)} = 84,100 \text{ lb}$$

$$V = 1.2 S_{DS} W / R = [(1.2)(0.402)(84,100)] / 2.2$$

$$V = 18,441 \text{ lb}$$

31 piles tied to floor diaphragm

So V/pile = 18,441 lb/31 piles

$$V = 595 \text{ lb/pile}$$

## 11.11 Load Combinations

It is conceivable that more than one type of natural hazard will occur at the same time. It is clearly possible, for example, for a flood to occur at the same time as a high wind event—this happens during most hurricanes. In addition, it is possible to have very heavy rain at the same time as high winds and flooding conditions. ASCE 7-98 addresses the various load combination possibilities. As noted at the beginning of this section, this manual uses ASD as the design method of choice.

The ASD method uses nominal loads, usually without load factors, to compute stresses due to axial loads, bending moments, shears, etc. The induced stresses are considered acceptable if they do not exceed allowable stress values specified in the appropriate material design standard referenced in the building code. This method inherently includes a factor of safety, which is the ratio of the specified strength of the material to the actual induced stress.

The following symbols are used in the definitions of the various load combinations:

<b>D</b>	dead load
<b>L</b>	live load
<b>F</b>	load due to fluids with well-defined pressures and maximum heights (e.g., fluid load in tank)
<b>F<sub>a</sub></b>	flood load
<b>H</b>	loads due to weight and lateral pressures of soil and water in soil
<b>T</b>	self-straining force
<b>L<sub>r</sub></b>	roof live load
<b>S</b>	snow load
<b>R</b>	rain load
<b>W</b>	wind load
<b>E</b>	earthquake load

When loads are combined with the ASD method, they are considered to act in the following combinations for buildings in V zones and coastal A zones (ASCE 7-98, Section 2.4.1), whichever produces the most unfavorable effect on the building or building element:

1.  $D$
2.  $D + L + F + H + T + (L_r \text{ or } S \text{ or } R)$
3.  $D + (W \text{ or } 0.7E) + L + (L_r \text{ or } S \text{ or } R) + 1.5F_a^*$
4.  $0.6D + W + H + 1.5 F_a^*$
5.  $0.6D + 0.7E + H$

\* For non-coastal A zones, the flood load shall be  $0.75F_a$  instead of  $1.5F_a$ .

Note the following:

- In V zones, coastal A zones, and non-coastal A zones, E shall be set equal to 0 in combination 3, above.
- In areas not subject to flooding, combination 3 becomes  $D + (W \text{ or } 0.7E) + L + (L_r \text{ or } S \text{ or } R)$
- In areas not subject to flooding, combination 4 becomes  $0.6D + W + H$

The *Commentary* in ASCE 7-98 states “Wind and earthquake loads need not be assumed to act simultaneously. However, the most unfavorable effects of each should be considered in design, where appropriate. In some instances, forces due to wind might exclude those due to earthquake, while ductility requirements might be determined by earthquake loads.”

The designer is cautioned that F is intended for fluid loads in tanks, not hydrostatic loads.  $F_a$  should be used for all flood loads, including hydrostatic loads, and should include the various components of flood loads as recommended in Section 11.6.12. It is important to note that the load combinations discussed in this section must be resolved directionally, so that all loads in a given combination are acting in the same direction, either vertically or horizontally. See page 11-59 for an example of how to calculate the appropriate load combination.



# Load Combination Example Problem

**Determined Previously:**

1. Flood loads (from page 11-33):

$$F_{sta} = 0$$

$$F_{dyn} = 21,816 \text{ lb}$$

$$F_{brkp} = 4,375 \text{ lb}$$

$$F_i = 758 \text{ lb}$$

2. Horizontal wind loads (using the projected area method):

$\Sigma$  wind forces to left = (pressure in each area) (area) or

$$(p_8)(A_8) + (p_8)(\text{front gable wall area}) + (p_2)(A_2) + (p_3)(A_3) + (p_9)(A_9) \text{ or}$$

$$\Sigma (14.44 \text{ lb/ft}^2)(440 \text{ ft}^2) + (14.44 \text{ lb/ft}^2)(288 \text{ ft}^2) - (12.63 \text{ lb/ft}^2)(352 \text{ ft}^2) + (20.01 \text{ lb/ft}^2)(480 \text{ ft}^2) + (17.55 \text{ lb/ft}^2)(600 \text{ ft}^2) = 30,648 \text{ lb}$$

3. Horizontal seismic shear force at foundation (from page 11-56):

$$V = 18,441 \text{ lb above ground}$$

**Find:**

Total horizontal load required for foundation design.

1.  $D = 0$  in horizontal direction

2.  $D + L + F + H + T + (L_r \text{ or } S \text{ or } R)$

$$0 + 0 + 0 + 0 + 0 = 0$$

3.  $D + (W \text{ or } 0.7E) + L + (L_r \text{ or } S \text{ or } R) + 1.5F_a$

$$0 + [30,648 \text{ or } (0.7)(18,441)] + 0 + 0 + 1.5 (21,816 + 4,375) = 69,934 \text{ lb (controls)}$$

4.  $0.6D + W + H + 1.5F_a$

$$0 + 30,648 + 0 + 39,286 = 69,934 \text{ lb (controls)}$$

5.  $0.6D + 0.7E + H$

$$0 + 12,909 + 0 = 12,909 \text{ lb}$$

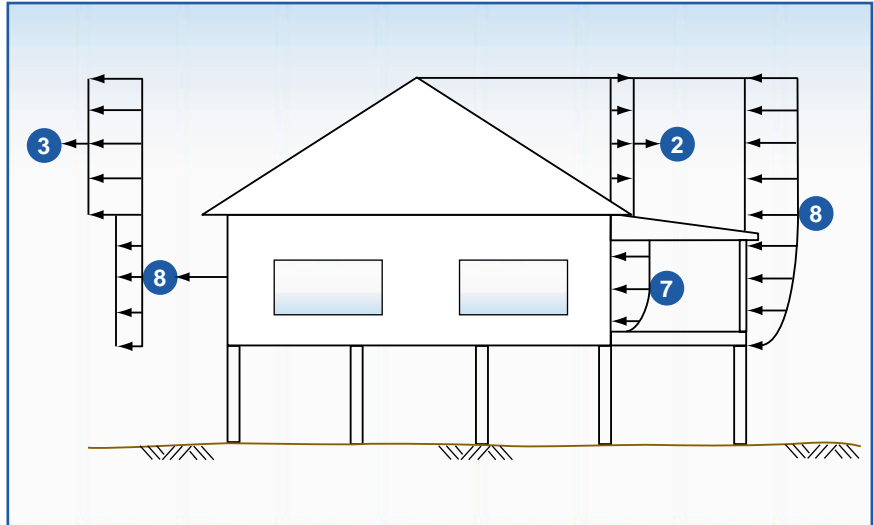

**Figure 11-29** Side view of building shown in Figure 11-23.

## Load Combination Computation Worksheet

Owner Name: \_\_\_\_\_ Prepared by: \_\_\_\_\_

Address: \_\_\_\_\_ Date: \_\_\_\_\_

Property Location: \_\_\_\_\_

### Variables

D (dead load) =

L (live load) =

F (fluid load) =

$F_a$  (flood load) =

H (lateral soil and water in soil load) =

T (self-straining force) =

$L_r$  (roof live load) =

S (snow load) =

R (rain load) =

W (wind load) =

E (earthquake load) =

### Summary of Load Combinations:

1.

2.

3.

4.

5.

### Combination No. 1

**D =**

### Combination No. 2

**D + L + F + H + T + ( $L_r$  or S or R) =**

### Combination No. 3

**D + W + L + ( $L_r$  or S or R) +  $1.5F_a^*$  =**

### Combination No. 4

**$0.6D + W + H + 1.5F_a^*$  =**

### Combination No. 5

**$0.6D + 0.7E + H =$**

\* Use  $0.75F_a$  for non-coastal A zones and 0 for all structures outside SFHAs.

**Note:** The load combinations calculated with this worksheet are arithmetic sums. The combinations **must** be broken down into horizontal and vertical components and summed in each direction.



## 11.12 References

- American Institute of Architects. 1994. *AIA Wind Design Primer*.
- American Society of Civil Engineers. 1995. *Wave Forces on Inclined and Vertical Wall Surfaces*.
- American Society of Civil Engineers. 1998a. *Flood Resistant Design and Construction*. ASCE Standard ASCE 24-98.
- American Society of Civil Engineers. 1998b. *Minimum Design Loads for Buildings and Other Structures*. ASCE Standard ASCE 7-98.
- Camfield, F. E. 1980. *Tsunami Engineering*. Special Report No. 6. U.S. Army, Coastal Engineering Research Center. February.
- Chopra, A. K. 1995. *Dynamics of Structures: Theory and Applications to Earthquake Engineering*. Upper Saddle River, NJ: Prentice-Hall, Inc.
- Dames & Moore. 1980. *Design and Construction Standards for Residential Construction in Tsunami-Prone Areas of Hawaii*. Prepared for the Federal Emergency Management Agency.
- Federal Emergency Management Agency. 1995a. *Engineering Principles and Practices for Retrofitting Flood Prone Residential Buildings*. FEMA 259. January.
- Federal Emergency Management Agency. 1995b. *Guidelines and Specifications for Wave Elevation Determination and V Zone Mapping*, Final Draft. March.
- Federal Emergency Management Agency. 1997. *NEHRP Recommended Provisions for Seismic Regulations for New Buildings*. FEMA 302A.
- Federal Emergency Management Agency. 1998. *Taking Shelter From the Storm: Building a Safe Room in Your House*. FEMA 320.
- Fox, R. W.; A. T. McDonald. 1985. *Introduction to Fluid Mechanics*. New York: John Wiley & Sons, Inc.
- International Code Council. 2000a. *International Building Code*. Birmingham, AL. July.
- International Code Council. 2000b. *International Residential Code for One- and Two-Family Dwellings*. Birmingham, AL.

Mehta, K.; R. Marshall. 1995. *Guide to the Use of the Wind Load Provisions*.

Ramsey, C. G.; H. R. Sleeper. 1996. *Architectural Graphic Standards*, J. N. Boaz, ed. New York: John Wiley & Sons, Inc.

U. S. Army Corps of Engineers. 1984. *Shore Protection Manual*.

U. S. Army Corps of Engineers. 1992. *Floodproofing Regulations*. EP 1165-2-314.

Walton, T. L. Jr.; J. P. Ahrens; C. L. Truitt; R. G. Dean. 1989. *Criteria for Evaluating Coastal Flood-Protection Structures*. CERC Technical Report 89-15. U. S. Army Corps of Engineers Waterways Experiment Station.